

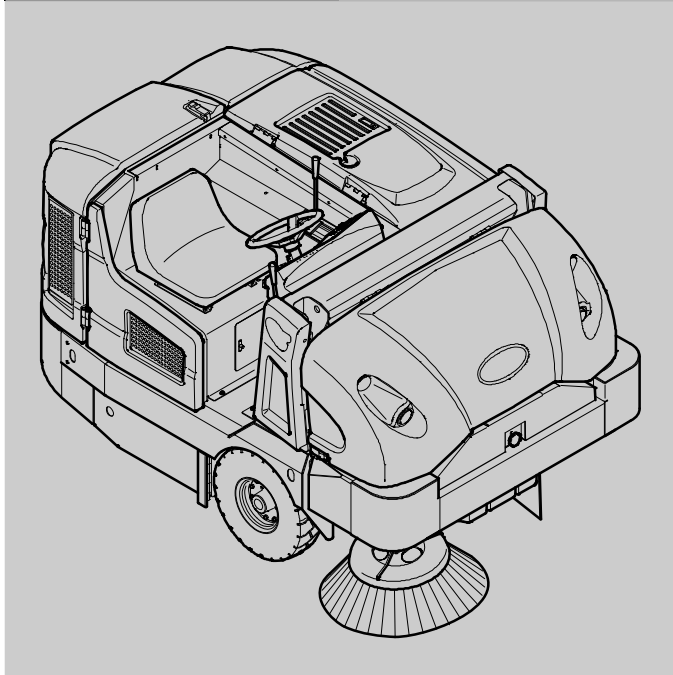

S30

(Gas/LPG)



Sweeper Operator Manual



SweepMax[®] Plus
Tennant True[®] Parts
IRIS[®] a Tennant Technology

North America / International



For the latest parts manuals and other
language Operator manuals, visit:

www.tennantco.com/manuals

9004080
Rev. 14 (07-2019)



INTRODUCTION

This manual is furnished with each new model. It provides necessary operation and maintenance instructions.



Read this manual completely and understand the machine before operating or servicing it.

This machine will provide excellent service. However, the best results will be obtained at minimum costs if:

- The machine is operated with reasonable care.
- The machine is maintained regularly - per the machine maintenance instructions provided.
- The machine is maintained with manufacturer supplied or equivalent parts.

PROTECT THE ENVIRONMENT	MACHINE DATA
	Please fill out at time of installation for future reference.
Please dispose of packaging materials, used components such as batteries and fluids in an environmentally safe way according to local waste disposal regulations.	Model No. - _____
	Serial No. - _____
Always remember to recycle.	Installation Date - _____

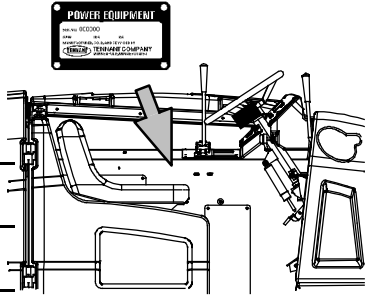

INTENDED USE

The S30 is an industrial rider machine designed to sweep hard surfaces (concrete, asphalt, stone, synthetic, etc). Typical applications include industrial warehouses, manufacturing facilities, distribution facilities, stadiums, arenas, convention centers, parking facilities, transportation terminals, and construction sites. Do not use this machine on soil, grass, artificial turf, or carpeted surfaces. This machine can be used both indoors and outdoors, but ensure there is adequate ventilation if used indoors. Do not use this machine other than described in this Operator Manual.



CALIFORNIA PROPOSITION 65 WARNING:

Engine exhaust from this product contains chemicals known to the State of California to cause cancer, birth defects, or other reproductive harm.

Tennant Company

PO Box 1452

Minneapolis, MN 55440

Phone: (800) 553- 8033

www.tennantco.com

Thermo- Sentry, 1- STEP, EasyOpen, MaxPro, InstantAccess, II- Speed, Perma- Filter, Duramer, Lower Total Cost of Ownership, Touch- N- Go, Watershield Dust Control and Cab Forward ErgoSpace are trademarks of Tennant Company.

Specifications and parts are subject to change without notice.

Original Instructions, Copyright © 2008, 2009, 2010, 2012, 2013 - 2019 TENNANT Company, Printed in U.S.A.

CONTENTS

	Page		Page
Important Safety Instructions – Save These		Machine Troubleshooting	36
Instructions	3	Hepa Filter System Troubleshooting	37
Operation	7	Maintenance	38
Machine Components	7	Maintenance Chart	38
Controls And Instruments	8	Lubrication	43
Touch Panel (S30 Xp And X4)	9	Engine Oil	43
Symbol Definitions	10	Rear Wheel Support	43
Operation Of Controls	11	Steering Cylinder Bearing	43
Directional Pedal	11	Hopper Lift Arm Bearings	43
Brake Pedal	11	Front Wheel Bearings	43
Parking Brake Pedal	11	Hydraulics	44
Steering Column Tilt Pedal	11	Hydraulic Fluid	45
Fuel Gauge	12	Hydraulic Hoses	45
Gasoline Machines	12	Engine	46
Lpg Machines	12	Cooling System	46
Hour Meter	13	Clean The Engine And Engine	
Supervisor Control Buttons		Compartment	47
(S30 Xp And X4)	13	Air Filter Indicator	48
Engine Speed Controls	13	Air Filter	48
Vacuum Fan Controls (S30)	14	Fuel Filter (Gasoline)	49
Vacuum Fan Controls (S30 Xp And X4)	14	Fuel Filter (Lpg)	49
Contrast Control Button		Electronic Pressure Regulator (Lpg)	
(S30 Xp And X4)	14	(S/N 000000 – 005699)	50
Filter Shaker Control (S30)	15	Lpg Vaporizer	50
Filter Shaker Control (S30 Xp And X4)	15	Spark Plugs – Gm Engines	
Operating / Hazard Light Switch	15	(S/N 000000 – 005699)	50
Side Brush Light Switch (Option)	15	Spark Plugs – Mitsubishi Engines	
Hopper Access Door	16	(S/N 005700 –)	50
Operator Seat	17	Engine Belt	51
Deluxe Suspension Seat	17	Timing Belt – Gm Engines	
Seat Belts	17	(S/N 000000 – 005699)	51
Brush Information	18	Camshaft And Balance Shaft Belts –	
How The Machine Works	19	Mitsubishi Engines	
Pre-Operation Checklist	20	(S/N 005700 –)	51
Changing The Lpg Tank	21	Pcv System	51
Starting The Machine	22	Battery	51
Turning Off The Machine	22	Fuses And Relays	52
While Operating The Machine	23	Relay Panel Fuses And Relays	52
Sweeping (S30)	24	Engine Harness Fuses And Relays	53
Sweeping (S30 Xp And X4)	25	Cab Fuses (Cab Option)	53
Emptying The Hopper	26	Hepa (High Efficiency Particulate	
Engaging The Hopper Support Bar	27	Arrestance) Filtration System (Option)	54
Disengaging The Hopper Support Bar	28	Hopper	54
Display Module Fault Indicators (S30)	29	Removing And Inspecting The Dust Filter	
Fault Indicator(S) (S30 Xp And X4)	30	(S/N 000000 – 006500)	55
Dash Fault Indicators	31	Removing And Inspecting The Dust Filter	
Options	32	(S/N 006501 –)	56
Wand (Option)	32	Check Dust Filter Seal Height	
Heater / Air Conditioner Controls		(S/N 006501 –)	57
(Option)	33	Cleaning The Dust Filter	58
Windshield Wiper Switch (Option)	33	Machines With Standard	
Cab Light Switch (Option)	33	Filtration System	58
Wet Side Brush Dust Control (Option)	34	Machines Equipped With Hepa	
Tower Bumpers (Option)	35	Filtration System	58
Turn Signal Switch (Option)	35		

CONTENTS

	Page		Page
Cleaning The Cyclone Assembly		Storage Information	78
(S/N 006501 –)	59	Freeze Protection For Wet Side Brush	
Cleaning The Upper Cyclone Chamber	59	Dust Control System	78
Cleaning The Lower Cyclone Chamber	60	Specifications	79
Cleaning The Lower Cyclone Chamber		General Machine Dimensions/Capacities	79
(Hepa Option)	60	General Machine Performance	79
Cyclone Perma-Filter		Power Type	80
(S/N 006501 –)	62	Hydraulic System	81
Inspect And Clean The Hepa Filter		Steering	81
Housing (Option)	63	Braking System	81
Main Brush	65	Tires	81
Replacing Or Rotating The Main Brush	65	Machine Dimensions	82
Checking The Main Brush Pattern	67		
Adjusting The Main Brush Taper	67		
Adjusting The Main Brush Width	68		
Side Brush	68		
Replacing The Side Brush	68		
Adjusting The Side Brush Pattern	69		
Rotating And Replacing The Side			
Brush Guard	69		
Skirts And Flaps	70		
Hopper Skirts	70		
Brush Door Skirts	70		
Rear Skirts	70		
Side Brush Dust Control Skirts (Option)	70		
Recirculation Flap	71		
Cyclonic Chamber And Dust Tray Flaps			
(S/N 006501 –)	71		
Seals	72		
Brush Door Seals	72		
Hopper Seals	72		
Hopper Access Door Seals	72		
Filter Chamber Inlet Seal	72		
Dust Return Seals			
(S/N 000000 – 006500)	73		
Dust Filter Seals			
(S/N 000000 – 006500)	73		
Vacuum Wand Door Seals (Option)	73		
Cyclone Cover Seals			
(S/N 006501 –)	73		
Cyclone Cover Access Port Seal			
(S/N 006501 –)	73		
Hopper Dust Filter Cover Seal			
(S/N 006501 –)	73		
Brakes And Tires	74		
Brakes	74		
Tires	74		
Rear Wheel	74		
Propelling Motor	74		
Wet Side Brush Dust Control (Option)	75		
Filter Screen	75		
Spray Nozzles	75		
Pushing, Towing, And Transporting The			
Machine	76		
Pushing Or Towing The Machine	76		
Transporting The Machine	76		
Machine Jacking	78		

IMPORTANT SAFETY INSTRUCTIONS – SAVE THESE INSTRUCTIONS

The following precautions are used throughout this manual as indicated in their description:

 **WARNING: To warn of hazards or unsafe practices that could result in severe personal injury or death.**

 **CAUTION: To warn of unsafe practices that could result in minor or moderate personal injury.**

FOR SAFETY: To identify actions that must be followed for safe operation of equipment.

The following information signals potentially dangerous conditions to the operator. Know when these conditions can exist. Locate all safety devices on the machine. Report machine damage or faulty operation immediately.

 **WARNING: Moving belt and fan. Keep away.**

 **WARNING: Machine emits toxic gases. Serious injury or death can result. Provide adequate ventilation.**

 **WARNING: Raised hopper may fall. Engage hopper support bar.**

 **WARNING: Lift arm pinch point. Stay clear of hopper lift arms.**

 **WARNING: Burn hazard. Hot surface. Do NOT touch.**

 **WARNING: Accident may occur. Do not operate vacuum or blower wand while driving.**

 **CAUTION: LPG engine will run for a few seconds after key is turned off. Apply parking brake before leaving machine.**

This machine may be equipped with technology that automatically communicates over the cellular network. If this machine will be operated where cell phone use is restricted because of concerns related to equipment interference, please contact a Tennant representative for information on how to disable the cellular communication functionality.

FOR SAFETY:

1. **Do not operate machine:**
 - Unless trained and authorized.
 - Unless operator manual is read and understood.
 - Under the influence of alcohol or drugs.
 - While using a cell phone or other types of electronic devices.
 - Unless mentally and physically capable of following machine instructions.
 - If it is not in proper operating condition.
 - Without filters in place.
 - In areas where flammable vapors/liquids or combustible dusts are present.
 - In areas that are too dark to safely see the controls or operate the machine unless operating / headlights are turned on.
 - In areas with possible falling objects unless equipped with overhead guard.
2. **Before starting machine:**
 - Check machine for fluid leaks
 - Keep sparks and open flame away from refueling area.
 - Make sure all safety devices are in place and operate properly.
 - Check brakes and steering for proper operation.
 - Adjust seat and fasten seat belt (if equipped).
3. **When starting machine:**
 - Keep foot on brake and directional pedal in neutral.

SAFETY PRECAUTIONS

4. When using machine:

- Use only as described in this manual.
- Do not pick up burning or smoking debris, such as cigarettes, matches or hot ashes
- Use brakes to stop machine.
- Go slow on inclines and slippery surfaces.
- Do not sweep on ramp inclines that exceed 14% grade or transport (GVWR) on ramp inclines that exceed 17% grade.
- Reduce speed when turning.
- Keep all parts of body inside operator station while machine is moving.
- Always be aware of surroundings while operating machine.
- Use care when reversing machine.
- Move machine with care when hopper is raised.
- Do not raise hopper when machine is on an incline.
- Make sure adequate clearance is available before raising hopper.
- Keep children and unauthorized persons away from machine.
- Do not carry passengers on any part of the machine.
- Always follow safety and traffic rules.
- Report machine damage or faulty operation immediately.

5. Before leaving or servicing machine:

- Do not park near combustible materials, dusts, gases, or liquids.
- Stop on level surface.
- Set parking brake.
- Turn off machine and remove key.

6. When servicing machine:

- All work must be done with sufficient lighting and visibility.
- Keep work area well ventilated.
- Avoid moving parts. Do not wear loose clothing, jewelry and secure long hair.
- Block machine tires before jacking machine up.
- Jack machine up at designated locations only. Support machine with jack stands.
- Use hoist or jack that will support the weight of the machine.
- Do not push or tow the machine without an operator in the seat.
- Do not power spray or hose off machine near electrical components.
- Disconnect battery connections before working on machine.

- Avoid contact with battery acid.
- Avoid contact with hot engine coolant.
- Do not remove cap from radiator when engine is hot.
- Allow engine to cool.
- Keep flames and sparks away from fuel system service area. Keep area well ventilated.
- Use cardboard to locate leaking hydraulic fluid under pressure.
- All repairs must be performed by a trained service mechanic.
- Do not modify the machine from its original design.
- Use Tennant supplied or approved replacement parts.
- Wear personal protective equipment as needed and where recommended in this manual.



For Safety: wear hearing protection.



For Safety: wear protective gloves.



For Safety: wear eye protection.





For Safety: wear protective dust mask.

7. When loading/unloading machine onto/off truck or trailer:

- Empty debris hopper before loading machine.
- Turn off machine and remove key.
- Use ramp, truck or trailer that will support the weight of the machine and operator.
- Do not load/unload on ramp inclines that exceed 25% grade.
- Use winch. Do not drive the machine onto/off the truck or trailer unless the load height is 380 mm (15 in) or less from the ground.
- Set parking brake after machine is loaded.
- Block machine tires.
- Tie machine down to truck or trailer.

The safety labels appear on the machine in the locations indicated. Replace damaged labels.

WARNING LABEL – Machine emits toxic gases. Serious injury can result. Provide adequate ventilation.

 	▲ WARNING Machine emits toxic gases. Serious injury or death can result. Provide adequate ventilation.	▲ AVERTISSEMENT La machine produit des gaz toxiques. Ces gaz peuvent provoquer des blessures ou la mort. Veillez à ce que l'endroit soit bien aéré.	▲ ADVERTENCIA La máquina emite gases tóxicos. Pueden provocar lesiones graves o fatales. Asegúrese de que existe suficiente ventilación.
--	--	---	--

Located on the side of the operator compartment.

WARNING LABEL – Moving belt and fan. Keep away.

▲ WARNING 
Moving belt and fan. Keep away.
▲ AVERTISSEMENT La courroie et le ventilateur sont en mouvement. Ne vous approchez pas.
▲ ADVERTENCIA Correa y ventilador en movimiento. Manténgase alejado.

Located on engine belt guard.

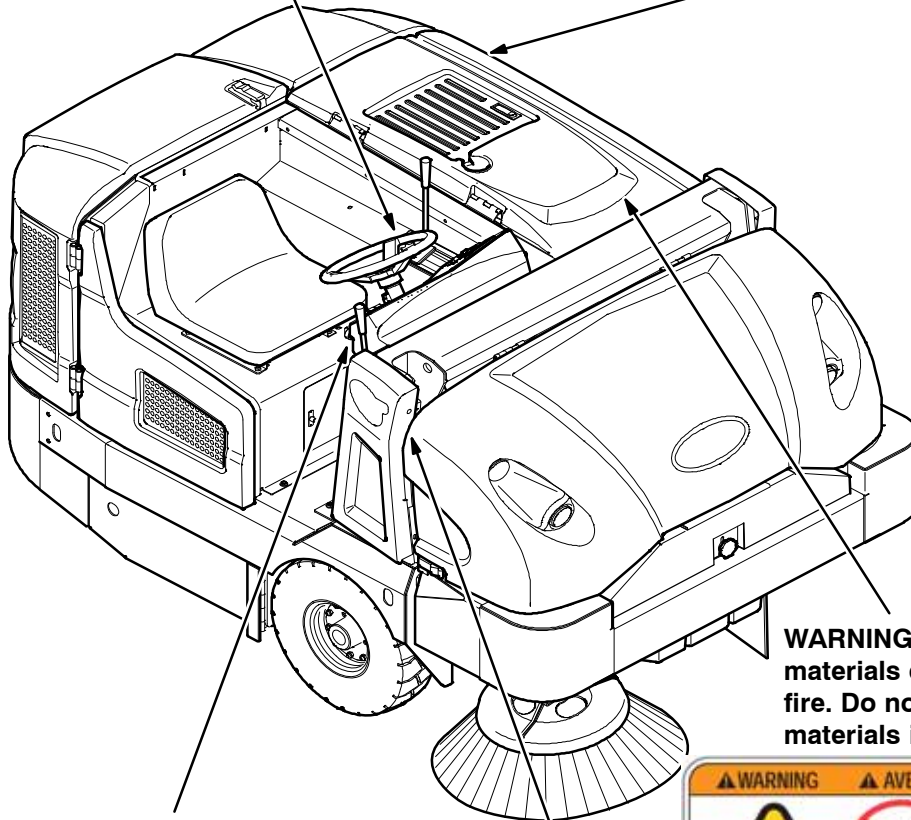



WARNING LABEL – Flammable materials can cause explosion or fire. Do not use flammable materials in tank.

▲ WARNING 	▲ AVERTISSEMENT 	▲ ADVERTENCIA 	
Flammable materials can cause explosion or fire. Do not use flammable materials in tank. Only use water.	Les matières inflammables peuvent causer une explosion ou un incendie. N'utilisez pas de matières inflammables dans le(s) réservoir(s). Utilisez uniquement de l'eau.	Los materiales inflamables pueden provocar explosiones o incendios. No utilice materiales inflamables en el depósito(s). Utilice agua exclusivamente.	

Located on the tank.

CAUTION LABEL – LPG engine will run for a few seconds after key is turned off. Apply parking brake before leaving machine.

  	▲ CAUTION ▲ ATTENTION ▲ ATENCIÓN LPG engine will run for a few seconds after key is turned off. Apply parking brake before leaving machine.	Le moteur à GPL tourne encore quelques secondes une fois le contact coupé. Engagez le frein de stationnement avant de quitter la machine.	El motor LPG seguirá funcionando algunos segundos después de retirar la llave de contacto. Aplique el freno de estacionamiento antes de abandonar la máquina.
---	---	---	---

Located next to the ignition switch on the instrument panel. (LPG machines only)

WARNING LABEL – Lift arm pinch point. Stay clear of hopper lift arms.

	▲ WARNING Lift arm pinch point. Stay clear of hopper lift arms.
	▲ AVERTISSEMENT Attention au point d'articulation du bras d'élevation. Ne vous approchez pas des bras d'élevation de la trémie.
	▲ ADVERTENCIA Punto de pinzamiento del brazo elevador. No se acerque a los brazos elevadores de la caja colector.

Located on both hopper lift arms.

SAFETY PRECAUTIONS

WARNING LABEL – Burn hazard. Do NOT touch.

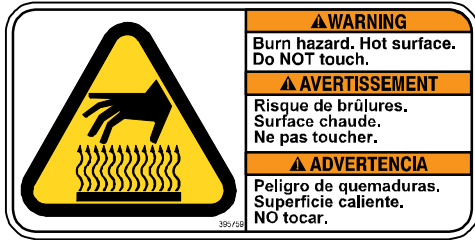

Located on the exhaust shield.

WARNING LABEL – Raised hopper may fall. Engage hopper support bar.

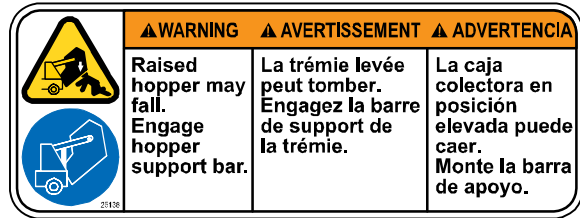

Located on the hopper support bar.

FOR SAFETY LABEL – Read manual before operating machine.

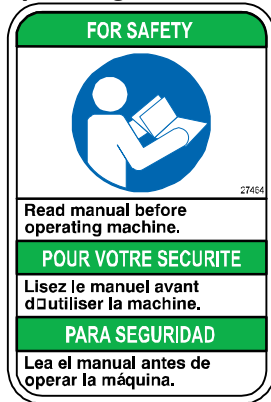

Located on the side of the operator compartment.

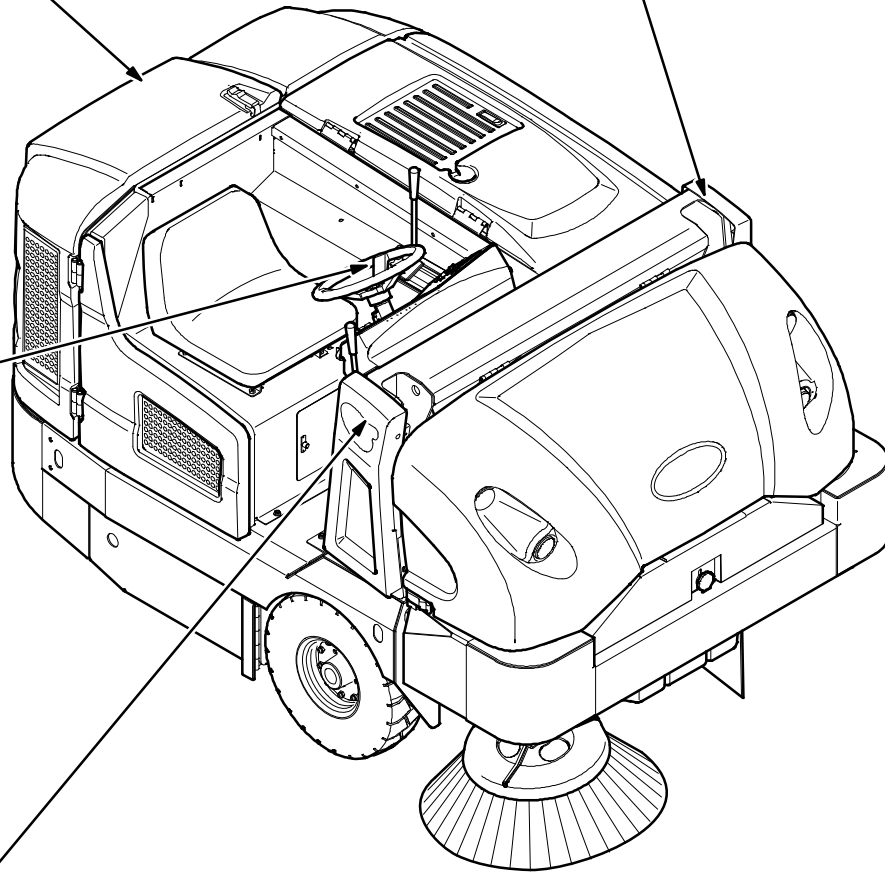

WARNING LABEL – Raised hopper may fall. Engage hopper support bar.

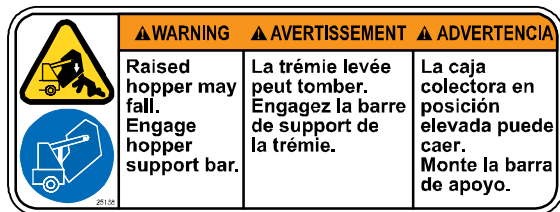

Located on the hopper lift arm.

WARNING LABEL – Accident may occur. Do not operate vacuum or blower wand while driving.

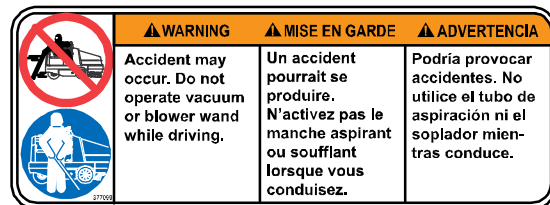

Located on the optional vacuum or blower wand door.

354590

OPERATION

MACHINE COMPONENTS



- | | |
|---------------------------|--------------------------|
| 1. Instrument panel | 9. Operator seat |
| 2. Front shroud | 10. Rear engine shroud |
| 3. Hopper access door | 11. Taillights |
| 4. Hopper | 12. Side shroud |
| 5. Side brush | 13. Hopper support bar |
| 6. Headlights | 14. Top cover |
| 7. Main brush access door | 15. Water tank (option) |
| 8. Fuel tank | 16. HEPA filter (option) |

OPERATION

CONTROLS AND INSTRUMENTS

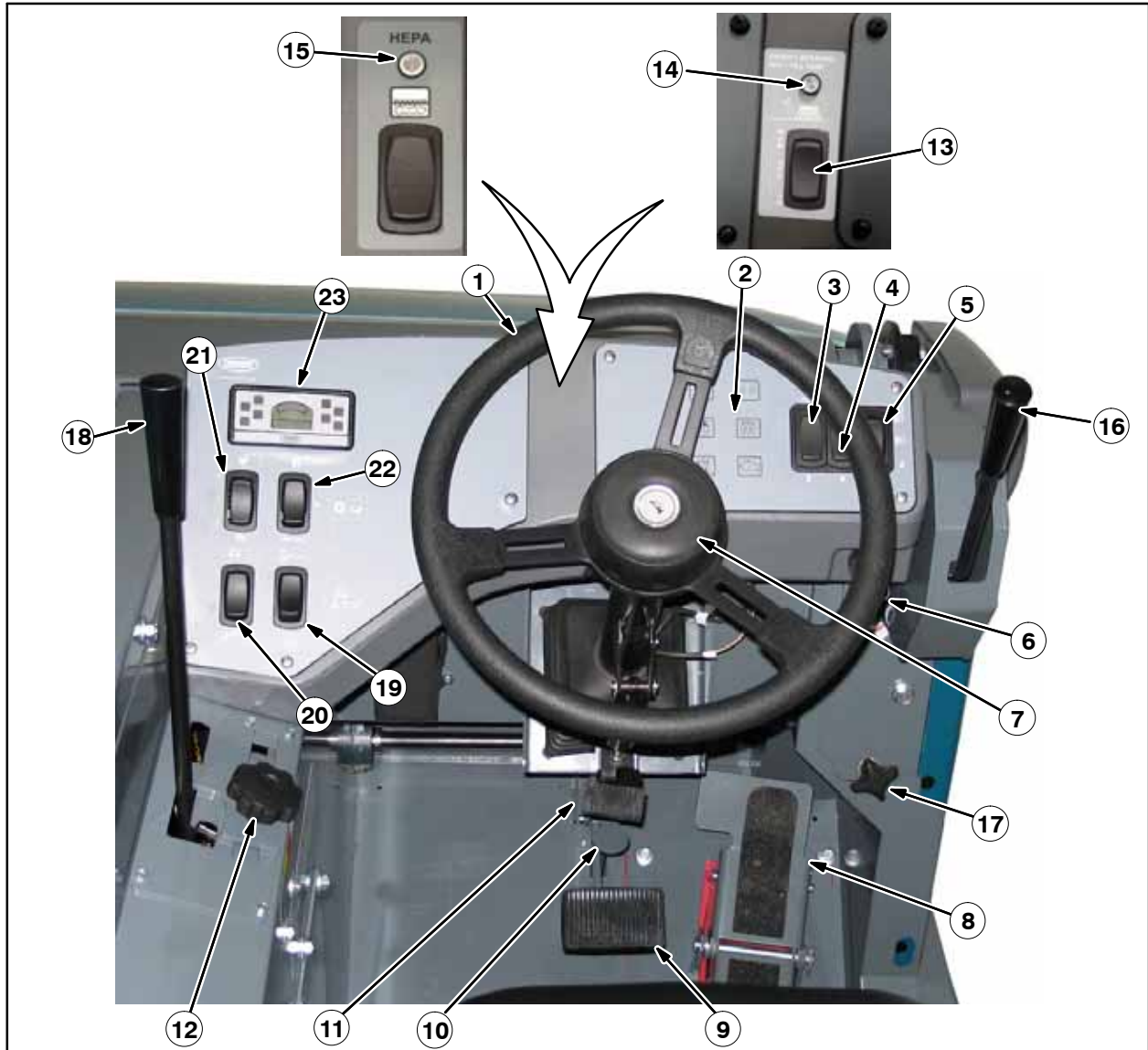

(All models)

1. Steering wheel
2. Dash fault indicator lights
3. Wand switch (option)
4. Side brush light switch (option)
5. Operating / hazard light switch
6. Ignition switch
7. Horn button
8. Directional pedal
9. Brake pedal
10. Parking brake pedal
11. Steering column tilt pedal
12. Main brush adjustment knob

13. Wet side brush dust control switch (option)

14. Wet side brush dust control indicator light (option)
15. HEPA fault indicator (option)

(S30 only)

16. Side brush lever
17. Side brush adjustment knob
18. Main brush lever
19. Hopper door switch
20. Hopper raise / lower switch
21. Engine speed switch
22. Vacuum fan / filter shaker switch
23. Indicator panel

TOUCH PANEL (S30 XP and X4)

































1. Supervisor control buttons
2. Hour meter / fuel indicator / fault code indicator
3. Contrast control button
4. 1-STEP sweep button
5. Engine speed button
6. Vacuum fan button
7. Side brush button
8. Hopper door open button
9. Hopper door close button
10. Hopper lower button
11. Hopper raise button
12. Filter shaker button
13. Fault indicator light

OPERATION

SYMBOL DEFINITIONS

These symbols are used on the machine to identify controls, displays, and features. See also *Display Module Fault Indicators (S30)* and *Dash Fault Indicators*.

 Sweep (S30)	 Jack point
 Vacuum fan (S30)	 Fault indicator (S30 XP and X4)
 Filter Shaker (S30)	 Contrast Control (S30 XP and X4)
 Engine Idle Speed (S30)	 1-STEP Sweep (S30 XP and X4)
 Engine High speed (S30)	 Engine speed (S30 XP and X4)
 Empty Hopper (S30)	 Vacuum fan (S30 XP and X4)
 Hopper Door Automatic (S30)	 Side brush (S30 XP and X4)
 Hopper Door Manual Open (S30)	 Filter shaker (S30 XP and X4)
 Hopper Lower (S30)	 Hopper Up / Down (S30 XP and X4)
 Hopper Raise (S30)	 Hopper raise (S30 XP and X4)
 Wand	 Hopper lower (S30 XP and X4)
 Operating lights	 Open/Close Hopper Door (S30 XP, X4)
 Hazard light	 Hopper door open (S30 XP and X4)
 Horn	 Hopper door close (S30 XP and X4)
 Unleaded fuel only	 Wet side brush dust control (option)

OPERATION OF CONTROLS**DIRECTIONAL PEDAL**

Press the top of the *Directional pedal* to move forward and the bottom of the pedal to move backward. The pedal returns to the neutral position when it is released.

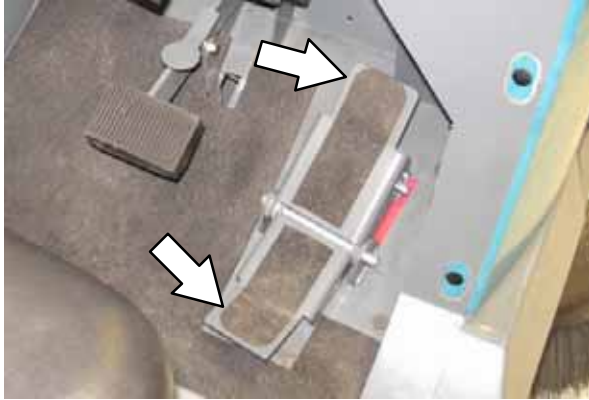
**BRAKE PEDAL**

Press the *Brake pedal* to stop the machine.

**PARKING BRAKE PEDAL**

Press the *Brake pedal* down as far as possible and use toe to lock the *Parking brake pedal* into place. Press the *Brake pedal* to release the parking brake. The *Parking brake pedal* will return to the unlocked position.

**STEERING COLUMN TILT PEDAL**

1. Step on the *Steering column tilt pedal* and adjust the steering column to the desired position.
2. Release the *Steering column tilt pedal* to lock in place.

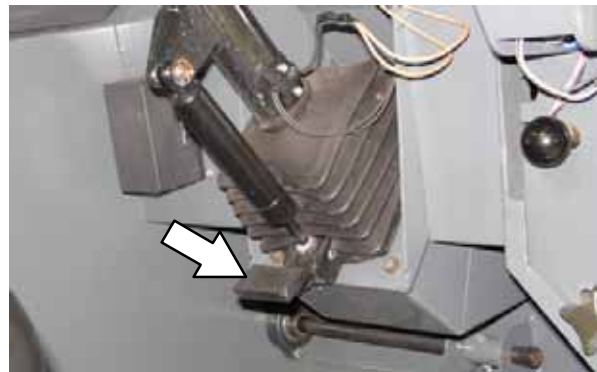

OPERATION

FUEL GAUGE

GASOLINE MACHINES

NOTE: Do not use leaded fuels. Leaded fuels will permanently damage the system oxygen sensor and catalytic converter.

The *Fuel indicator* displays the amount of fuel left in the tank. The fuel level fault indicator will illuminate when the fuel tank is near empty. Refer to *DISPLAY MODULE FAULT INDICATOR(S)*.

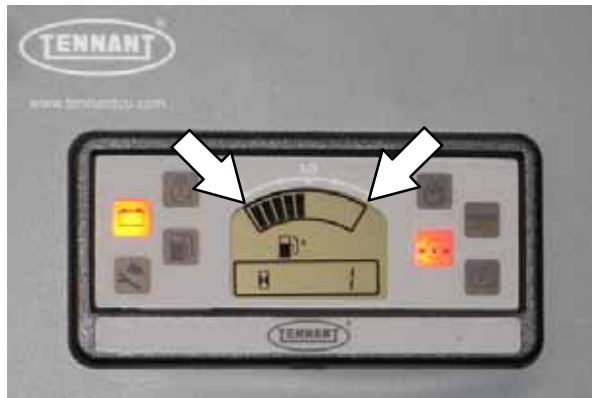

S30

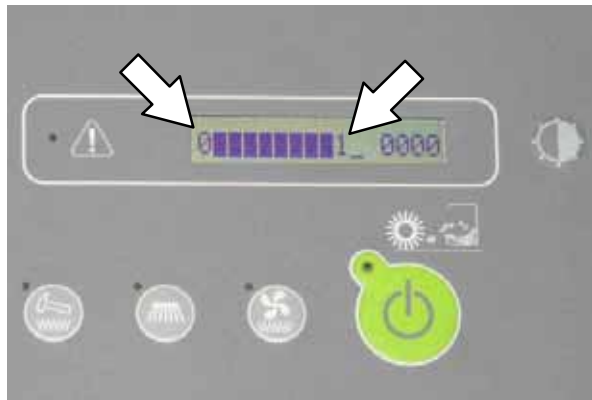

S30 XP and X4

LPG MACHINES

For LPG machines, the *Fuel indicator* does NOT display the amount of fuel in the LPG tank. It will display all the indicator bars to show that some fuel is in the tank. The fuel level fault indicator will illuminate when the fuel level gets low. Refer to *DISPLAY MODULE FAULT INDICATOR(S)*.

The LPG *fuel gauge* on the tank displays the amount of fuel in the LPG tank.

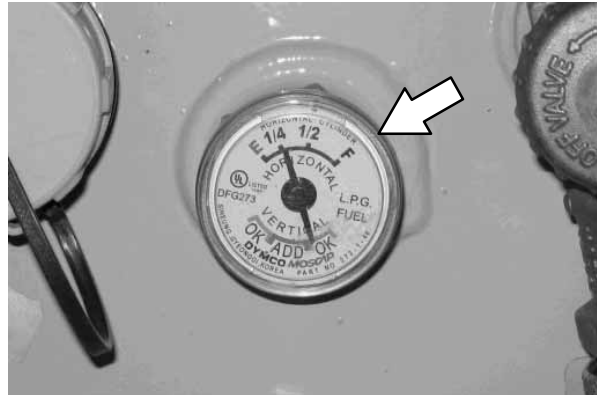

HOURLY METER

The *Hour meter* records the hours the machine was operated. Use this information to determine machine service intervals.



S30

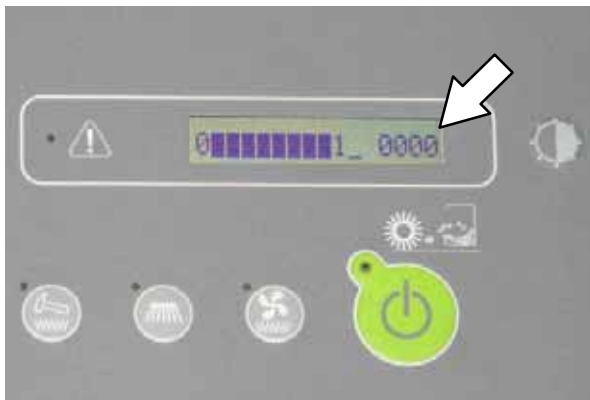

S30 XP and X4

**SUPERVISOR CONTROL BUTTONS
(S30 XP and X4)**

The *Supervisor Control buttons* are for accessing the configuration and diagnostic modes. Only properly trained service personnel and TENNANT representatives should access these modes.

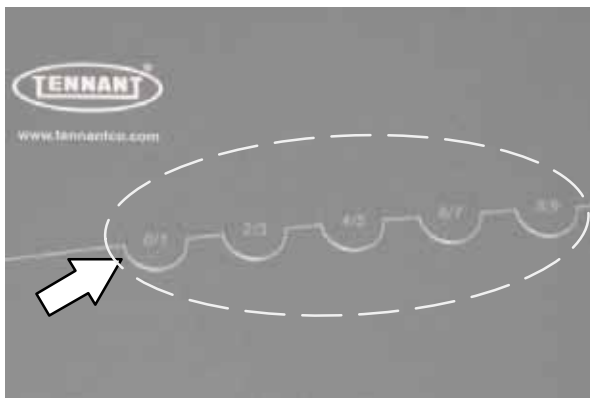

ENGINE SPEED CONTROLS

Idle Speed: This speed is for starting the machine.

NOTE: S30 XP and X4 machines automatically start in idle speed.

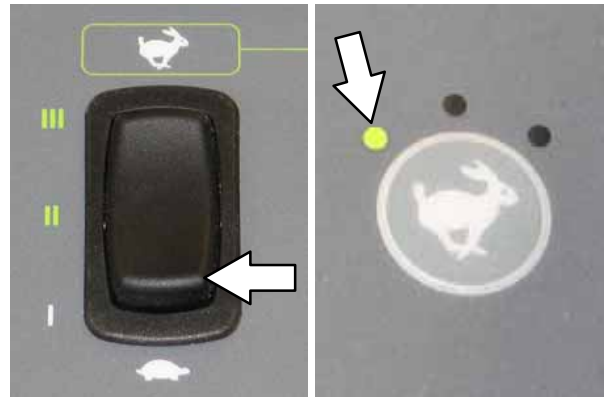

S30

S30 XP and X4

Medium (Fast 1) Speed: This speed is for general sweeping.

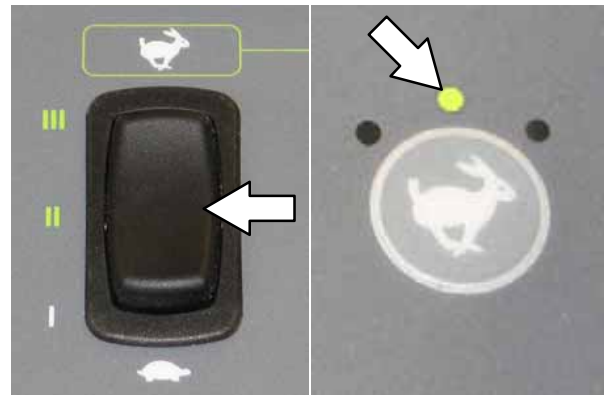

S30

S30 XP and X4

High (Fast 2) Speed: This speed is for sweeping light litter or moving quickly between areas.

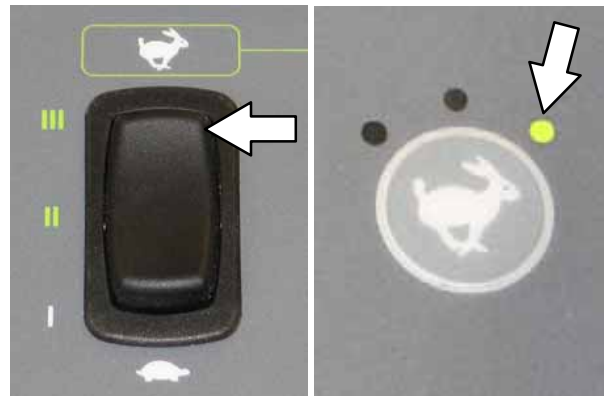

S30

S30 XP and X4

OPERATION

VACUUM FAN CONTROLS (S30)

The vacuum fan automatically comes on when the main brush is lowered with the *Vacuum fan switch* in the automatic/on position.

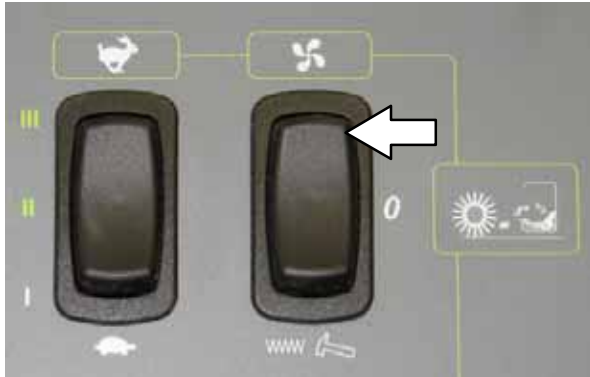

NOTE: Turn off the vacuum fan when sweeping over large wet areas or standing water. This prevents the dust filter from getting wet while sweeping.

Press the *Vacuum fan switch* to the middle position to shut off the vacuum fan.

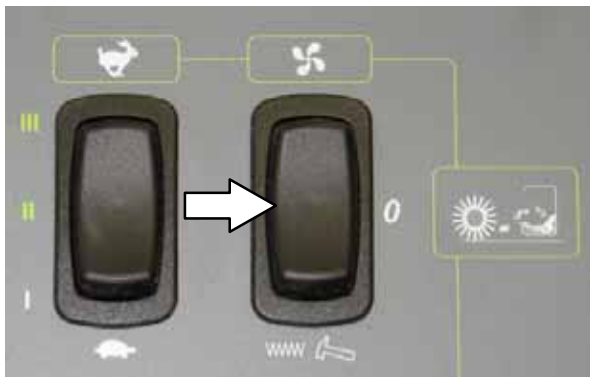

VACUUM FAN CONTROLS (S30 XP and X4)

The vacuum fan automatically comes on when the *1-STEP Sweep button* is activated. The light next to the *Vacuum fan button* will come on.

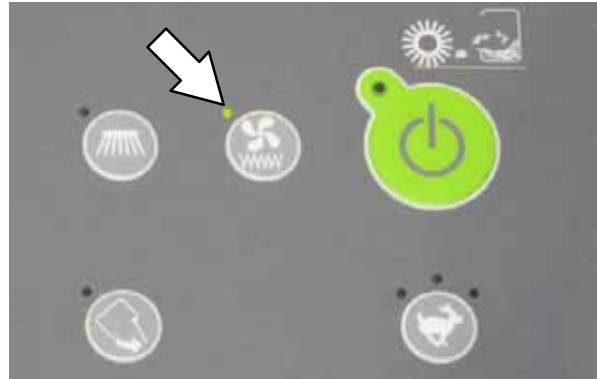

NOTE: Turn off the vacuum fan when sweeping over large wet areas or standing water. This prevents the dust filter from getting wet while sweeping.

Press the *Vacuum fan button* to shut off the vacuum fan. The light next to the button will go out.



CONTRAST CONTROL BUTTON (S30 XP and X4)

Press and hold the *Contrast control button* to darken/lighten the LCD display.



FILTER SHAKER CONTROL (S30)

Press the *Filter shaker switch*. The filter shaker will operate for 30 seconds.

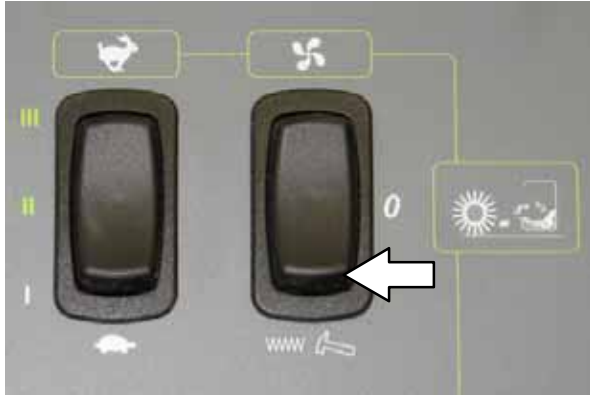

FILTER SHAKER CONTROL (S30 XP and X4)

The filter shaker automatically activates for about 30 seconds when the *1-STEP Sweep button* is turned off.

Press the filter shaker switch to manually start the 30 second shaker cycle or to stop the shaker cycle.



OPERATING / HAZARD LIGHT SWITCH

Operating and Hazard Lights On: Press the top of the *Operating / hazard light switch*.

Operating Lights On: Press the *Operating / hazard light switch* to the middle position.

All Lights Off: Press the bottom of the *Operating / hazard light switch*.

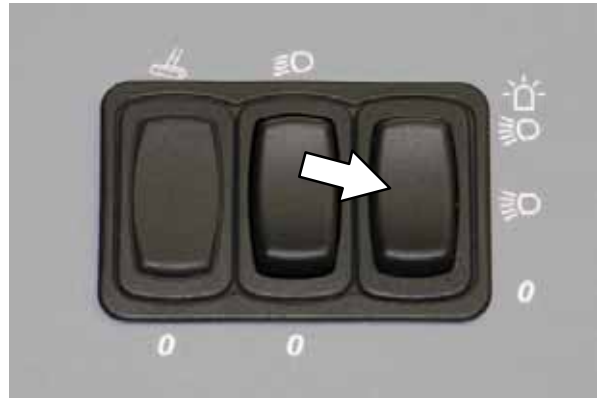

SIDE BRUSH LIGHT SWITCH (OPTION)

Side Brush Lights On: Press the top of the *Side brush light switch* to turn the side brush light on.

Side Brush Lights Off: Press the bottom of the *Side brush light switch* to turn the side brush light off.

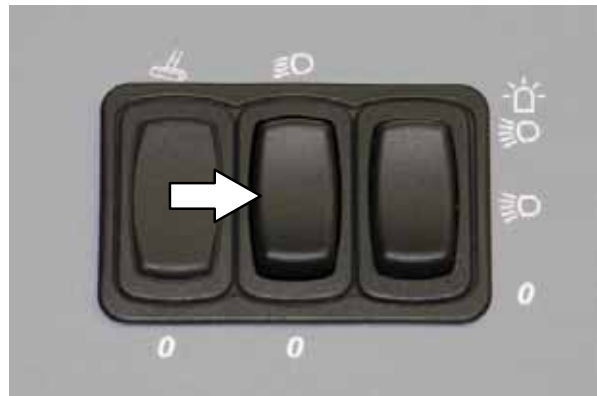

OPERATION

HOPPER ACCESS DOOR

Use the hopper access door to dispose of debris too large to be picked up by the machine while sweeping.

Twist the hopper access door handle to loosen the lock, lift the handle to disengage the lock, and then lift the hopper access door open.

(SN 000000 – 006500)



Pull the hopper access door handle to open the hopper access door. (SN 006501 –)



OPERATOR SEAT

The front-to-back adjustment lever adjusts the seat position.

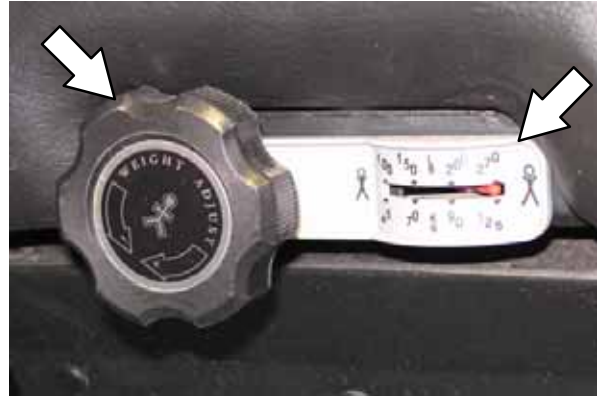

The weight adjustment knob controls the firmness of the operator seat. Use the gauge next to the weight adjustment knob to help determine seat firmness.

**DELUXE SUSPENSION SEAT**

The operator seat has three adjustments: backrest angle, operator weight, and front to back.

The backrest adjustment knob adjusts the angle of the backrest.

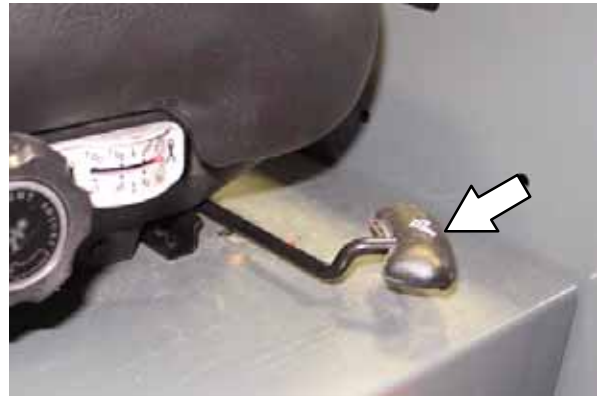

The front-to-back adjustment lever adjusts the seat position.

**SEAT BELTS**

FOR SAFETY: Before starting machine, adjust seat and fasten seat belt (if equipped).



BRUSH INFORMATION

For best results, use the correct brush type for the cleaning application.

NOTE: The amount and type of soilage play an important role in determining the type of brushes to use. Contact a Tennant representative for specific recommendations.

Polypropylene and Wire 8-double row Main Brush – Recommended for general sweeping, fine dust, and slightly impacted debris.

Polypropylene Sand Wedge Main Brush – Recommended for heavy accumulation of sand and other small particulates.

Polypropylene Window Main Brush – Recommended for light litter, especially on smooth floors.

Polypropylene 8-double row Main Brush – Recommended for lighter duty sweeping applications.

Nylon 8-double row Main Brush – Recommended for general sweeping, especially on rough or irregular surfaces. Nylon has a long wear life.

Nylon Full Fill Main Brush – Recommended for accumulation of sand and other small particulates. Nylon has a long wear life.

Nylon Patrol Main Brush – Recommended for bulky debris swept at faster speeds.

Wire 8-double row Main Brush – Recommended for general sweeping and slightly impacted debris.

Natural Fiber and Full Fill Main Brush – Recommended for accumulation of sand and other small particulates.

Polypropylene Side Brush – Recommended for general sweeping of light to medium debris.

Nylon Side Brush – Recommended for general sweeping of rough or irregular surfaces. Nylon has a long wear life.

Flat Wire Side Brush – Recommended for outdoor curb-side sweeping where dirt is heavy or compacted.

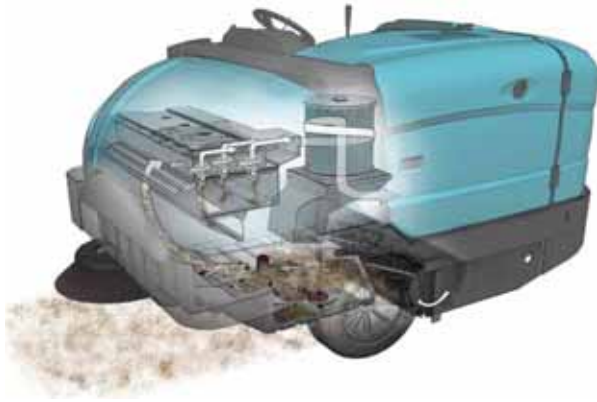
HOW THE MACHINE WORKS**Machines SN 000000 – 006500****Machines SN 006501 –**

The steering wheel controls the direction of machine travel. The directional pedal controls the speed and forward/reverse direction. The brake pedal slows and stops the machine.

The side brush sweeps debris into the path of the main brush. The main brush sweeps debris from the floor into the hopper. The vacuum system pulls dust and air through the hopper and the dust control system.

The machine also has a wet side brush dust control option to help contain dust.

**Machine with wet side brush dust control (Option)**

The machine also has an optional dry sweeping HEPA filtration system to help contain fine dust.

**Machines with HEPA filtration system (Option)**

When sweeping is finished, shake the dust filter and empty the hopper.

PRE-OPERATION CHECKLIST

- Check the fuel level.
- Check the machine for fluid leaks.
- Check the condition of the main brushes.
Remove string, banding, plastic wrap, or other debris wrapped around the brushes.
- Check the main brush compartment right skirts and seals for damage and wear.
- Check the dry dust control (option) skirts for damage and wear.
- Side Brush(es): Check the condition of the brush. Remove string, banding, plastic wrap, or other debris wrapped around the brush.
- Check the condition of the debris deflection skirts.
- Check the hydraulic fluid level.
- Check the main brush compartment left skirts and seals for damage and wear.
- Check the engine coolant level.
- Check the engine oil level.
- Check the radiator and hydraulic cooler fins for debris.
- Check the horn, headlights, taillights, safety lights, and backup alarm (if equipped).
- Check the brakes and steering for proper operation.
- Check the service records to determine maintenance requirements.
- Clean hopper
- Check the cyclonic chamber and dust trap flaps for wear, damage and ensure they open (HEPA option).

CHANGING THE LPG TANK

FOR SAFETY: Before leaving or servicing machine, stop on level surface, set parking brake, turn off machine, and remove key.

1. Open the side access door.
2. Close the LPG tank service valve.

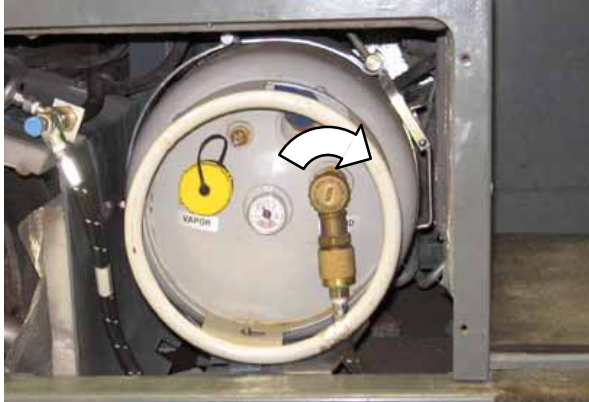

3. Start the machine and operate the engine until it stops from lack of fuel. Turn off the machine.

WARNING: Machine emits toxic gases. Severe respiratory damage or asphyxiation can result. Provide adequate ventilation. Consult with your regulatory authorities for exposure limits. Keep engine properly tuned.

FOR SAFETY: When servicing machine, keep flames and sparks away from fuel system service area. Keep area well ventilated.

4. Put on gloves and remove the quick disconnect tank coupling.



5. Open the LPG tank access door located in front of the operator seat.
6. Disengage the mounting strap, then remove the locating pin and remove the empty LPG fuel tank.



7. Align the hole in the tank collar with the centering pin and carefully place the full LPG tank onto the tray. Secure the tank with mounting strap.

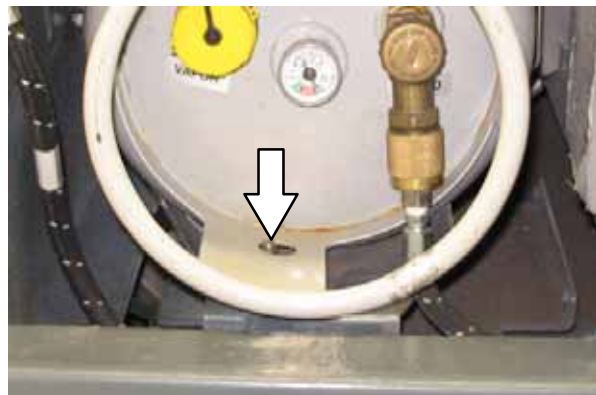

8. Connect the LPG fuel line to the tank service coupling. Make sure the tank service coupling is clean and undamaged and that it matches the fuel line coupling.
9. Slowly open the tank service valve and check for leaks. If a leak is found, immediately close the service valve and inform the appropriate personnel.

OPERATION

STARTING THE MACHINE

1. LPG powered machines: Slowly open the liquid service valve.

NOTE: Opening the service valve too quickly may cause the service check valve to stop the flow of LPG fuel. If the check valve stops the fuel flow, close the service valve, wait a few seconds, and slowly open the valve again.

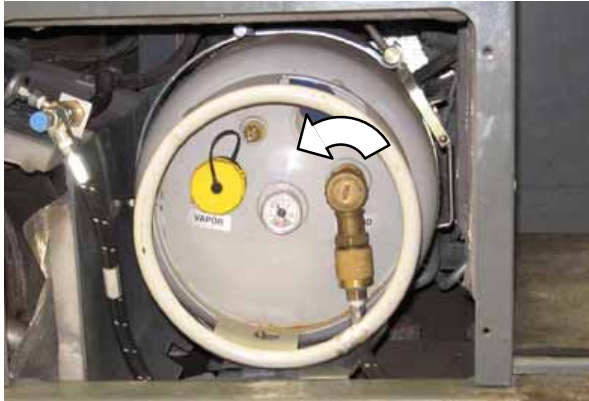

2. Sit in the operator seat and press the brake pedal or set the parking brake.

FOR SAFETY: When starting machine, keep foot on brake and directional pedal in neutral.

3. **S30:** Place the *Engine speed switch* into the idle position.

S30 XP and X4: The engine will automatically start in the idle speed.

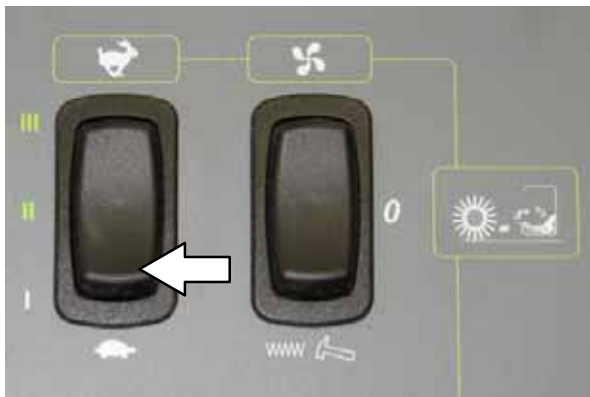

4. Turn the ignition switch key until the engine starts.

NOTE: Do not operate the starter motor for more than 10 seconds at a time or after the engine has started. Allow the starter to cool 15–20 seconds between starting attempts or damage to the starter motor may occur.



5. Allow the engine and hydraulic system to warm up for three to five minutes.

WARNING: Machine emits toxic gases. Severe respiratory damage or asphyxiation can result. Provide adequate ventilation. Consult with your regulatory authorities for exposure limits. Keep engine properly tuned.

6. Turn on lights.

TURNING OFF THE MACHINE

1. Stop the machine and turn off all sweeping functions.
2. Turn the ignition switch key counter clockwise to turn off the machine. Remain in the operator seat until the engine is off.

CAUTION: LPG engine will run for a few seconds after key is turned off. Apply parking brake before leaving machine.

NOTE: To protect engine emission components on LPG powered machines, the engine will continue to operate for a few seconds after the ignition switch is turned off.

FOR SAFETY: Before leaving or servicing machine, do not park near combustible materials, dust, gases, or liquids. Stop on level surface, set parking brake, turn off machine, and remove key.

WHILE OPERATING THE MACHINE

Pick up oversized debris before sweeping. Pick up wire, string, twine, large pieces of wood, or any other debris that could become wrapped around or tangled in the brushes.

Drive as straight a path as possible. Avoid bumping into posts or scraping the sides of the machine. Overlap the sweep paths by several centimeters (a few inches).

Avoid turning the steering wheel too sharply when the machine is in motion. The machine is very responsive to the movement of the steering wheel. Avoid sudden turns, except in emergencies.

Adjust the machine speed and brush pressure. Use the lowest brush pressure for best performance.

Keep the machine moving to prevent damaging floor finishes.

If poor cleaning performance is observed, stop cleaning and refer to *MACHINE TROUBLESHOOTING* in this manual.

Perform the Daily Maintenance Procedures after each use (see *MACHINE MAINTENANCE* in this manual).

Drive the machine slowly on inclines. Use the brake pedal to control machine speed on descending inclines. Sweep with the machine up inclines rather than down inclines.

FOR SAFETY: When using machine, go slowly on inclines and slippery surfaces.

Do not operate machine in areas where the ambient temperature is above 43° C (110° F). Do not operate sweeping functions in areas where the ambient temperature is below freezing 0° C (32° F). With the proper hydraulic fluid and a machine warm-up period, the machine is capable of operating at much lower temperatures.

FOR SAFETY: Do not sweep on ramp inclines that exceed 14% grade or transport (GVWR) on ramp inclines that exceed 17% grade.

OPERATION

SWEEPING (S30)

FOR SAFETY: Do not operate machine, unless operator manual is read and understood.

1. Start the machine.
2. Ensure the hopper is completely lowered.
3. Ensure the *vacuum fan switch* is in the automatic/on position.

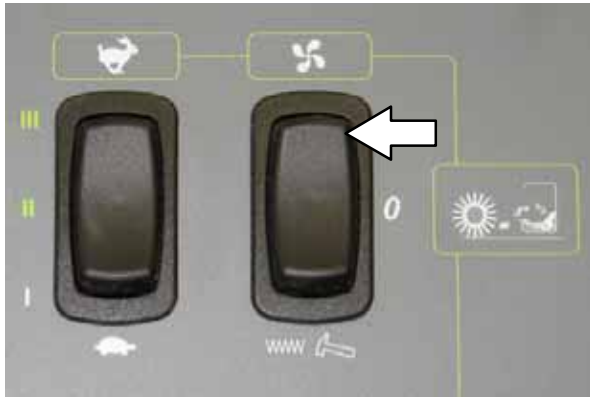

4. Ensure the *hopper door switch* is in the upper automatic position.



5. Select an engine speed. Use medium speed for general sweeping and high speed for sweeping light litter.

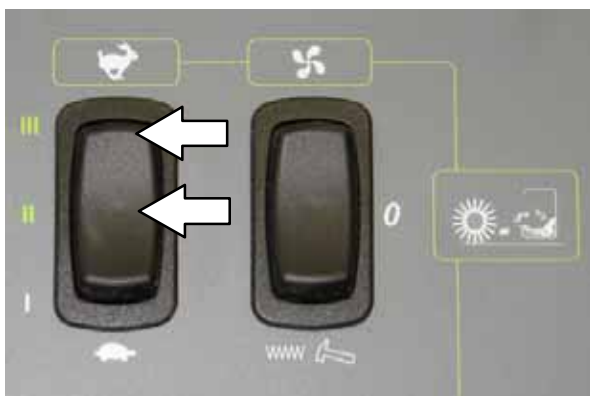

6. Turn on wet side brush dust control system if desired (option).



7. Lower the brushes.

NOTE: The brushes will rotate, the hopper door will open, and the vacuum fan will come on.

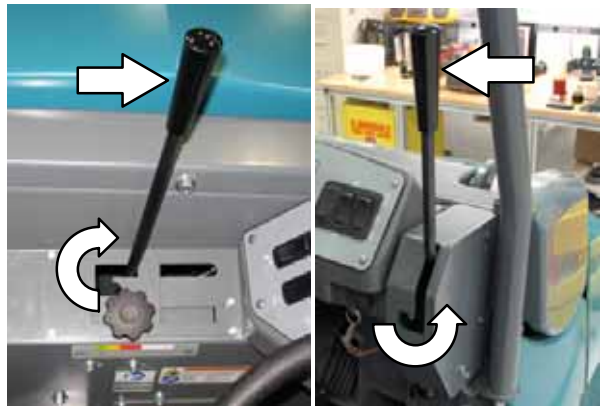

8. Release the *parking brake*, then press the *Directional pedal* to begin sweeping.

FOR SAFETY: When using machine, go slowly on inclines and slippery surfaces.

NOTE: Turn off the vacuum fan when sweeping over large wet areas or standing water. This prevents the dust filter from getting wet while sweeping.

9. To stop sweeping, press the *Brake pedal* to stop the machine.

10. Raise the brushes.



11. Press the *filter shaker switch* to activate the hopper filter shaker. It will operate for about 30 seconds.

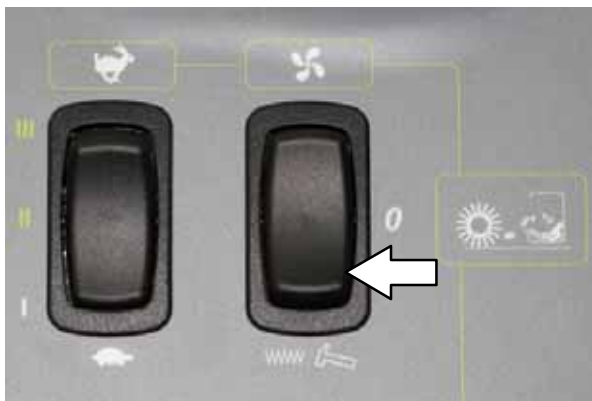

12. Empty the debris hopper at the end of each shift or as needed. See *EMPTYING THE HOPPER* section of this manual.

SWEEPING (S30 XP and X4)

FOR SAFETY: Do not operate machine, unless operator manual is read and understood.

1. Start the machine.

NOTE: Make sure the sweep modes / settings are set before sweeping.

2. Press the *1-STEP Sweep button*. All the preset sweeping functions will turn on. The light on the button will come on.

NOTE: The engine idle speed will increase, the brushes will rotate, the hopper door will open, and the vacuum fan will come on. Adjust the engine idle speed as needed.



3. Release the parking brake, then press the *Directional pedal* to begin sweeping.

FOR SAFETY: When using machine, go slowly on inclines and slippery surfaces.

NOTE: Turn off the vacuum fan when sweeping over large wet areas or standing water. This prevents the hopper dust filter from getting wet while sweeping.

4. To stop sweeping, press the *Brake pedal* to stop the machine.

5. Press the *1-STEP Sweep button*. The light on the button will turn off. All the preset sweeping functions will turn off and the automatic filter shaker will operate for about 30 seconds.

6. Empty the debris hopper at the end of each shift or as needed. See *EMPTYING THE HOPPER* section of this manual.

OPERATION

EMPTYING THE HOPPER

1. Slowly drive the machine to the debris site or debris container.
2. Stop the sweeping functions.
3. Press and hold the *Hopper raise switch or button* to raise the hopper.

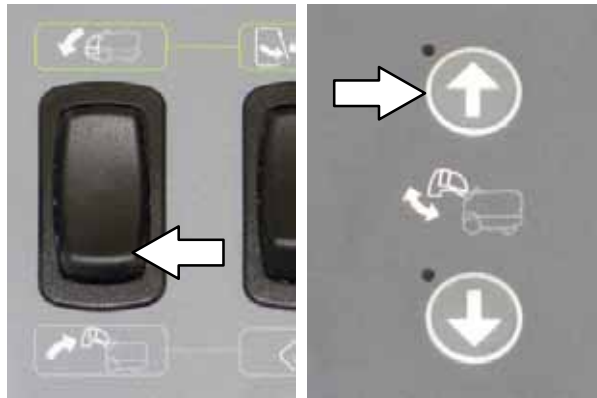

S30

S30 XP and X4

FOR SAFETY: When using machine, make sure adequate clearance is available before raising hopper. Do not raise hopper when machine is on an incline.

NOTE: Be aware the minimum ceiling height needed to raise the hopper is 2500 mm (98 in).

4. Slowly drive the machine up to the debris container.
- FOR SAFETY: When using machine, use care when reversing machine. Move machine with care when hopper is raised.**
5. Lower the hopper into the debris container to control dust.

NOTE: To prevent damaging the machine, DO NOT hit the debris container with the machine.

6. Open the hopper door to empty the hopper.



S30

S30 XP and X4

7. **S30:** Place the *Hopper door switch* in the automatic position to close the hopper door.

S30 XP and X4: Press the *Hopper door close button* to close the hopper door.



S30

S30 XP and X4

8. Raise the hopper enough to clear the top of the debris container.
9. Slowly back the machine away from the debris site or debris container.

10. Press and hold the *Hopper lower switch or button* to completely lower the hopper.



S30

S30 XP and X4

ENGAGING THE HOPPER SUPPORT BAR

The hopper support bar prevents the raised hopper from falling. Always engage the hopper support bar whenever leaving the hopper in the raised position.

1. Set the parking brake.
2. Start the machine.
3. Completely raise the hopper.



S30

S30 XP and X4

! WARNING: Lift arm pinch point. Stay clear of hopper lift arms.

FOR SAFETY: When using machine, make sure adequate clearance is available before raising hopper.

4. Rotate the support bar down into the hopper support clip.

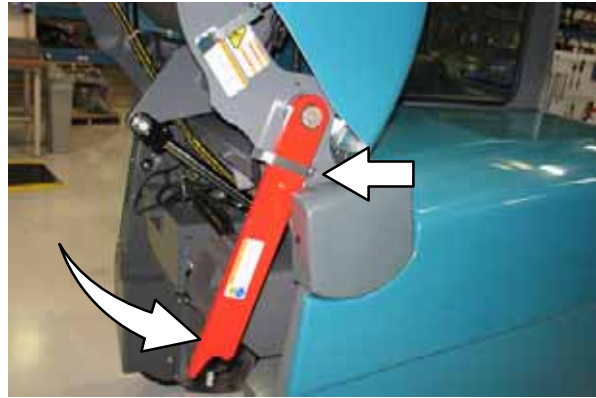

! WARNING: Raised hopper may fall. Engage hopper support bar.

5. Lower the hopper to lower the hopper support bar onto the bracket.



6. Turn off the machine.

OPERATION

DISENGAGING THE HOPPER SUPPORT BAR

1. Start the machine.
2. Completely raise the hopper.

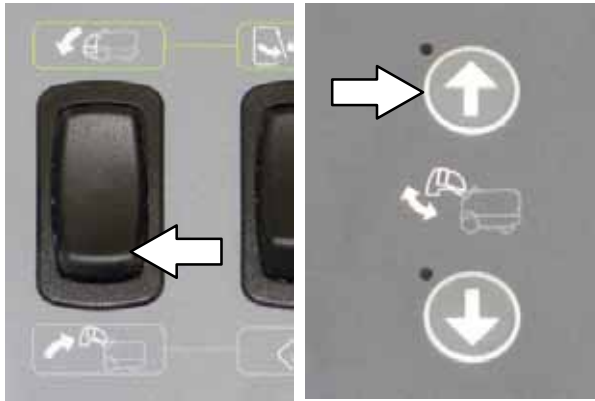

S30

S30 XP and X4

3. Set the parking brake.
4. Rotate the hopper support bar up into the storage clip.

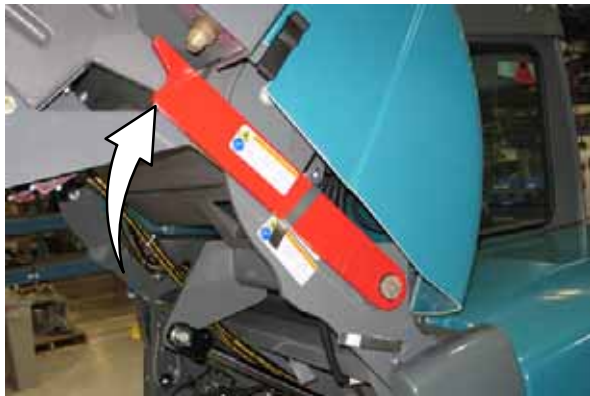

5. Completely lower the hopper.



WARNING: Lift arm pinch point. Stay clear of hopper lift arms.

DISPLAY MODULE FAULT INDICATORS (S30)

The *fault indicator lights* illuminate when a fault has occurred. Stop the machine immediately and correct the problem if these indicators come on.

Refer to the table below to determine the cause and remedy for the fault.

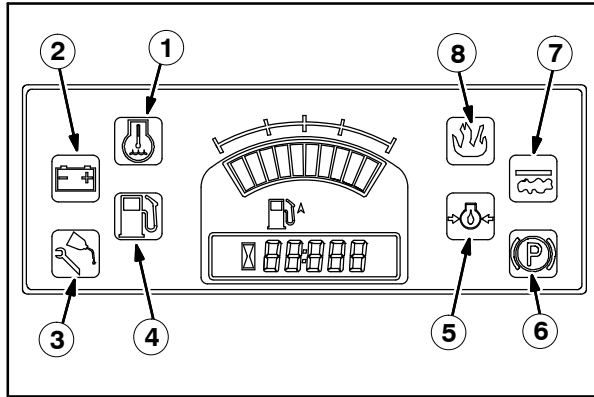

Fault Indicators	Cause(s)	Remedy
1: Water Temperature (Red) *GM engine (S/N 000000–005699)	Engine coolant is too hot to safely operate the machine	Shut off machine. Contact TENNANT service representative.
2: Charging System (Amber)	Alternator is not charging the battery.	Shut off machine. Contact TENNANT service representative.
3: Maintenance (Amber)	Not Used	Not Used
4: Fuel Level (Red)	Fuel level is low.	Refuel / Change fuel tank
5: Engine Oil Pressure (Red)	Oil pressure is below the normal operating pressure	Shut off machine. Contact TENNANT service representative.
6: Parking Brake (Amber)	Not Used	Not Used
7: Clogged Dust Filter (Amber)	Dust filter is clogged	Activate the filter shaker.
8: Hopper Fire (Red)	Fire in the hopper	Shut off machine. Extinguish fire. If necessary, call emergency personnel.

**NOTE: Mitsubishi engines machine serial number 005700 and above will display a “check engine” indicator and will automatically shut the machine off if the coolant is too hot.*

OPERATION

FAULT INDICATOR(S) (S30 XP and X4)

This machine is equipped with two visual indicators, a red indicator light and an LCD (liquid crystal display).

The red indicator light will blink continuously indicating that a fault has occurred.



The LCD will display a fault code. If there is more than one fault, each fault will alternately display.



All faults are also accompanied by an audible alarm to alert the operator a fault has occurred.

Refer to the table below to determine the cause and remedy for the fault.

Fault Code (Displayed in LCD)	Cause(s)	Result	Remedy
F3: CLOGGED HYD FILTER	Hydraulic filter is clogged	-	Shut off machine. Contact TENNANT service representative.
F4: SHAKER FILTER	Hopper dust filter is clogged	-	Activate filter shaker to unclog hopper dust filter.
F5: HOPPER FIRE	Fire in the hopper	Terminates sweeping functions and closes hopper door	Shut off machine. Extinguish fire. If necessary, call emergency personnel.
F6: ALTERNATOR	Alternator not charging		Contact TENNANT service representative.
F7: LOW OIL PRESS	Engine oil pressure is low	Shuts down engine	Contact TENNANT service representative.
F8: HIGH ENG TEMP *GM engine (S/N 000000-005699)	Engine temperature is high	Shuts down engine	Shut off machine. Contact TENNANT service representative.
F9: HIGH HYD TEMP	Hydraulic fluid temperature is high	Cancel 1-Step sweep functions	Shut off machine. Contact TENNANT service representative.
F10: LOW FUEL	Low fuel	-	Fill fuel tank (gasoline). Replace fuel tank (LPG).
F18: HOPPER UP	Hopper is up	Terminates sweeping functions-	Lower hopper completely.
F20: UP KEY ERR	Hopper up button failure	Prevents all panel operations	Shut off machine. Contact TENNANT service representative.
F21: DN KEY ERR	Hopper down button failure	Prevents all panel operations	Shut off machine. Contact TENNANT service representative.
F22: OPN KEY ERR	Hopper door open button failure	Prevents all panel operations	Shut off machine. Contact TENNANT service representative.
F23: CL KEY ERR	Hopper door close button failure	Prevents all panel operations	Shut off machine. Contact TENNANT service representative.
F24: SEAT SWITCH (Option)	Operator not in the seat while engine is running and parking brake not engaged	Engine will shut off	Engage parking brake before leaving the machine.
F25: SIDE SWEEP UNAVAILABLE	Side sweep is off when 1-STEP sweep is off	Side sweep will not come on	Turn on 1-STEP sweep then re-select side sweep.

**NOTE: Mitsubishi engines machine serial number 005700 and above will display a "check engine" indicator and will automatically shut the machine off if the coolant is too hot.*

DASH FAULT INDICATORS

The *dash fault indicators* illuminate when a fault has occurred. Stop the machine immediately and correct the problem if these indicators come on.

Refer to the table below to determine the cause and remedy for the fault.

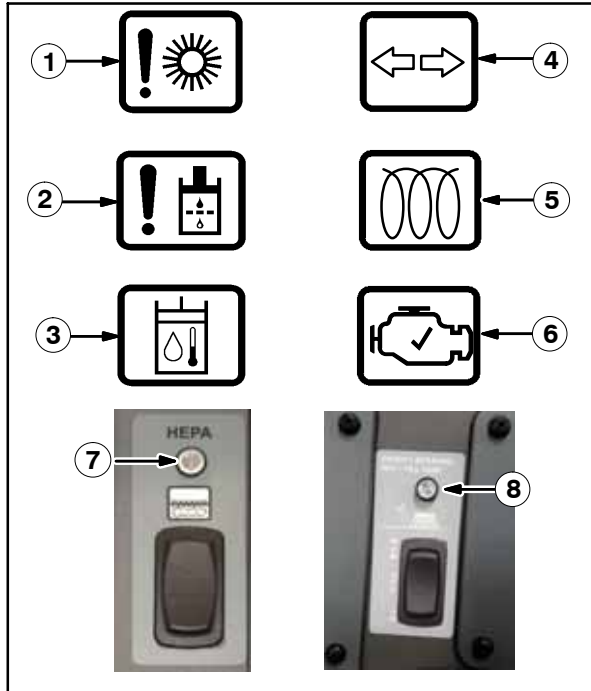

Warning Light	Cause(s)	Remedy
1: Stalled Brush	One of the brushes is stalled	Shut off machine and remove obstructions preventing brushes from operating
2: Hydraulic Filter	Hydraulic filter is clogged	Shut off machine. Contact TENNANT service representative
3: Hydraulic Temperature	Hydraulic system is too hot to safely operate the machine	Shut off machine. Contact TENNANT service representative
4: Hazard Flasher	Not Used	Not Used
5: Glow Plug – Preheat (Diesel machines only)	Not Used	Not Used
6: Check Engine	Engine control system detects a fault during machine operation	Shut off machine. Some fault conditions will automatically shut the machine off. Contact TENNANT service representative
7: HEPA (Option)	Restricted air flow through the HEPA filter.	Check the system for blockages, stuck flaps, or other air flow restrictions. Clean or replace HEPA filter
8: Wet side brush dust control (Option)	Water tank is empty.	Fill water tank

OPERATION

OPTIONS

WAND (OPTION)

The *vacuum wand* allows the operator to pick-up debris that is out of reach of the machine's sweeping path. The *blower wand* allows the operator to blow debris out from areas that are out of reach of the machine's sweeping path.

WARNING: Accident may occur. Do not operate vacuum or blower wand while driving.

1. Raise the brushes.
2. Stop the machine and turn off the engine.

FOR SAFETY: Before leaving or servicing machine, stop on level surface, set parking brake, turn off machine, and remove key.

3. Connect the hose assembly to the wand.

NOTE: The vacuum wand or the blower wand use the same hose assembly.

4. Attach the *vacuum wand* hose to the machine under the vacuum wand door located on the front of the hopper. Make sure the hopper door is closed when operating the vacuum wand.

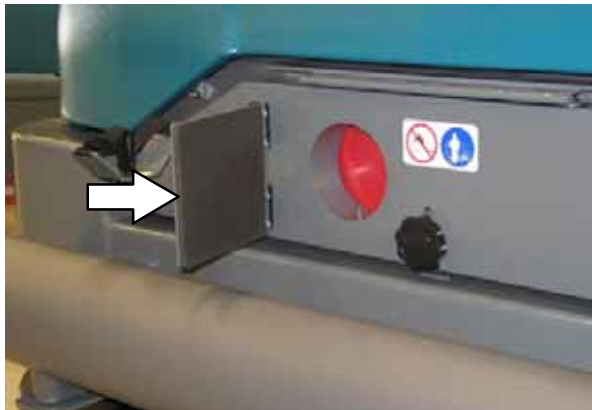

5. Attach the *blower wand* hose to the machine under the blower wand door located on the left side of the machine. Make sure the hopper door is open when operating the blower wand.

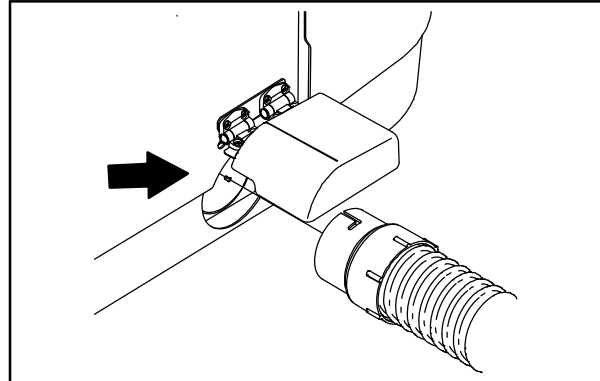

6. Start the machine.

WARNING: Machine emits toxic gases. Severe respiratory damage or asphyxiation can result. Provide adequate ventilation. Consult with your regulatory authorities for exposure limits. Keep engine properly tuned.

7. **S30:** Press the *Wand switch* to start the vacuum fan. Then set the engine to high speed.

S30 XP and X4: Press the *Vacuum fan button* to start the vacuum fan. The engine will automatically set to the high speed.

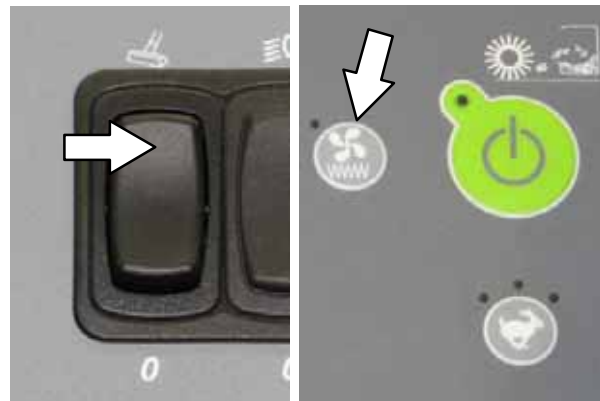

S30

S30 XP and X4

8. Clean the area as needed.
9. **S30:** Press the *Wand switch* to shut off the vacuum fan. Then set the engine to idle speed.

S30 XP and X4: Press the *Vacuum fan button* to shut off the vacuum fan. Then set the engine to idle speed.

10. Shut the machine off.
11. Disconnect the wand from the machine and return it to the storage location.

HEATER / AIR CONDITIONER CONTROLS (OPTION)

Use the *Heater / Air conditioner switch* to turn on the heater or air conditioner.

Top position: Air conditioner

Middle position: Off

Bottom position: Heater



Use the *Temperature knob* to control the cab heater temperature. Use the *Fan knob* to control the air conditioner temperature.



Use the *Fan knob* to control the fan speed. This knob affects the heater and air conditioner.



WINDSHIELD WIPER SWITCH (OPTION)

Use the *Windshield wiper switch* to turn on and adjust the windshield wiper speed.

Top position: High

Middle position: Low

Bottom position: Off



CAB LIGHT SWITCH (OPTION)

Press the *Cab light switch* to operate the cab light.



OPERATION

WET SIDE BRUSH DUST CONTROL (OPTION)

The *wet side brush dust control* is useful in dusty conditions to control the dust created by the side brush (es).

1. Set the Parking brake.

FOR SAFETY: Before leaving or servicing machine, stop on level surface, set parking brake, turn off machine and remove key.



2. Open the side and top covers then remove the water tank cap. Fill the tank with water. The water level can easily be seen on the side of the water tank. Replace the water tank cap.



WARNING: Flammable materials can cause explosion or fire. Do not use flammable materials in tank.

3. Close the side and top covers.

Use the *wet side brush dust control switch* to turn the water sprayer on and off.

Top (MOM) position: Water will spray *momentarily* while switch is held in this position.

Middle (OFF) position: Water sprayer is off.

Bottom (ON) position: Water will spray when the machine is moving. The indicator light will display green.

NOTE: if the indicator light displays red, the water tank is empty and needs to be filled.



TOWER BUMPERS (OPTION)

The tower bumpers help protect the rear engine cover from being damaged if the machine is backed into an obstruction. Open the tower bumpers before opening rear engine shroud.

To open the bumpers:

1. Pull the pin from the bracket and the bumper.



2. Open the bumper.



3. Close and secure the tower bumpers before operating the machine.

TURN SIGNAL SWITCH (OPTION)

Use the *Turn signal switch* to indicate the direction of the turn. The switch must be manually returned to the off position after the turn. Pull the switch out to activate the flashers.

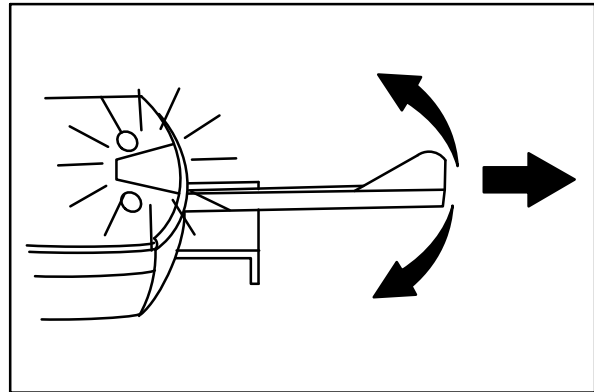

06745

OPERATION

MACHINE TROUBLESHOOTING

Problem	Cause	Remedy	
Excessive dusting	Brush skirts and dust seals worn, damaged, out of adjustment	Replace or adjust brush skirts or dust seals	
	Dust filter clogged	Shake and/or replace dust filter	
	Cyclones dirty / clogged	Clear blockage from cyclones	
	Vacuum hose damaged	Replace vacuum hose	
	Vacuum fan seal damaged	Replace vacuum fan seal	
	Vacuum fan failure	Ensure Thermo Sentry wires are connected Call Tennant service representative	
	Thermo-Sentry tripped	Allow Thermo-Sentry to cool	
	Water tank empty	Fill water tank	
	Wet side brush dust control switch not turned on (Option)	Turn on the wet side brush dust control switch	
	Wet side brush dust control filter clogged (Option)	Clean or replace filter	
	Wet side brush dust control nozzle clogged (Option)	Clean nozzle	
	Poor sweeping performance	Worn brush bristles	Replace brushes
		Brush pressure set too light	Increase brush pressure
Main brush not properly adjusted		Adjust brush	
Debris caught in main brush drive mechanism		Remove debris from main brush drive mechanism	
Main and/or side brush drive failure		Call Tennant service representative	
Hopper is full		Empty hopper	
Hopper lip skirts worn or damaged		Replace lip skirts	
Improper brushes		Refer to <i>Brush Information</i> or call Tennant service representative	
Engine speed set wrong		Set engine speed correctly	
Sweeping functions do not turn on	Hopper is up	Completely lower hopper	
	Fire in the hopper	Shut off machine. Extinguish fire. If necessary, call emergency personnel	
	S30 XP and X4: Hydraulic fluid too hot	Call Tennant service representative	

HEPA FILTER SYSTEM TROUBLESHOOTING

Refer to the troubleshooting table below and the troubleshooting procedures if excessive dust is noted on machines equipped with the HEPA filter during machine operation.

STEP	ACTION	NOT DUSTING	DUSTING
1	* Use electric shaker to shake primary dust filter * Empty hopper	Resume Sweeping	Proceed to Step 2
2	* Inspect seal at front hopper access door	Resume Sweeping	Proceed to Step 3
3	* Remove primary filter and place in plastic bag. * Manually tap filter to remove dust. * Inspect seal on filter cover * Inspect seal to vacuum fan inlet	Resume Sweeping	Proceed to Step 4
4	* Open Upper Cyclone clean out door and inspect * Vacuum out dust (use HEPA certified vacuum)	Resume Sweeping	Proceed to Step 5
5	* Raise hopper to inspect cyclone and primary dust filter debris tray flaps * Flaps must move freely * Remove debris buildup if flap movement is restricted	Resume Sweeping	Proceed to Step 6
6	* Inspect side brush dust control skirts for damage and adjustment	Resume Sweeping	Proceed to Step 7
7	* Raise hopper to inspect wheel pocket skirts * Open side brush doors and inspect skirts * Inspect sweep chamber skirts	Resume Sweeping	Proceed to Step 8
8	* Inspect HEPA filter box inlet hose. * Check for rips, attachment, and restrictions inside the hose	Resume Sweeping	Proceed to Step 9
9	* Check primary filter seal height on shaker plate * Measure height from shaker plate mount bracket to top of lower cyclone box	Resume Sweeping	Adjust dust filter seal height

MAINTENANCE

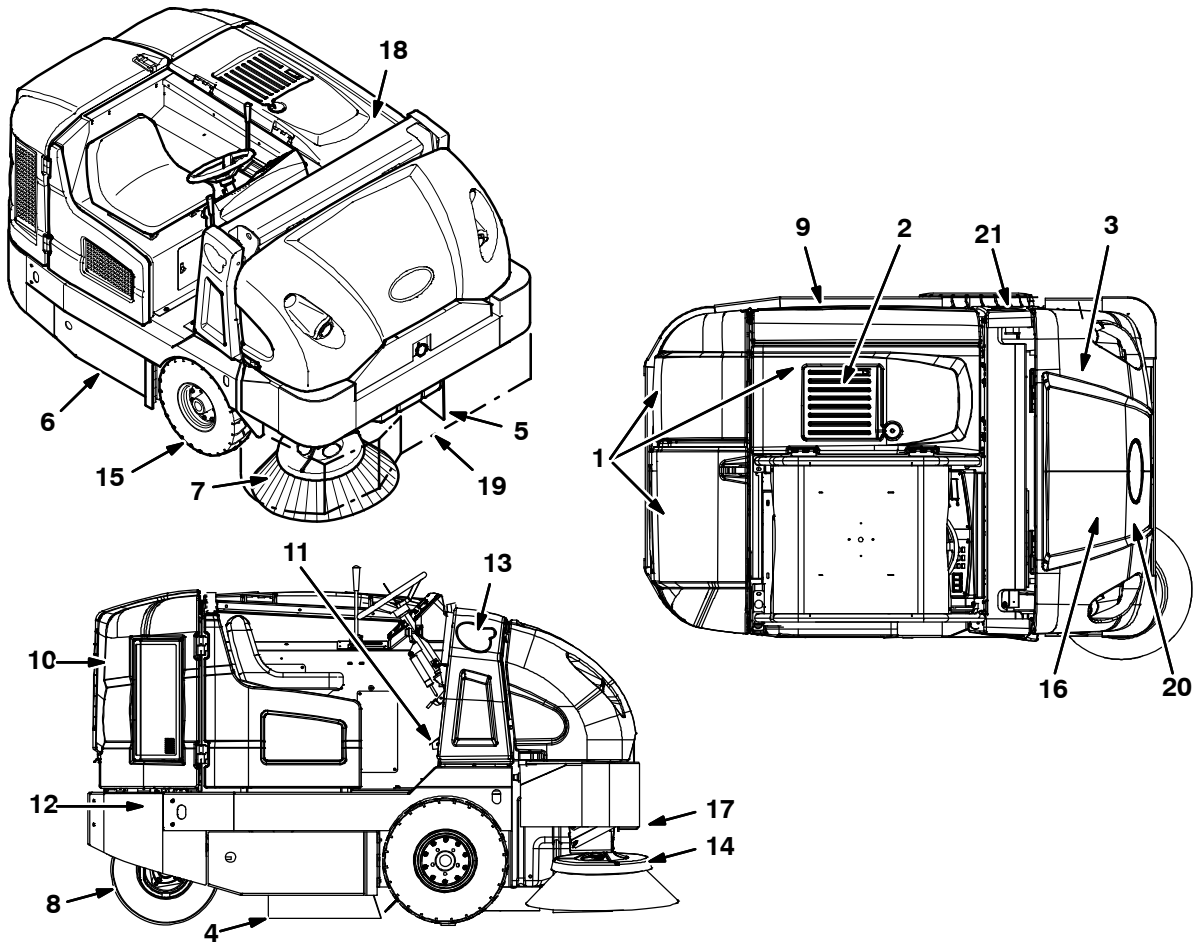

MAINTENANCE CHART

The table below indicates the *Person Responsible* for each procedure.

O = Operator.
T = Trained Personnel.

= Indicates unique maintenance schedule for machines equipped with HEPA filtration system.

Interval	Person Resp.	HEPA	Non-HEPA	Key	Description	Procedure	Lube/ Fluid	No. of Service Points
Daily/ 8 Hours	O			1	Engine	Check oil level	EO	1
						Check coolant level in reservoir	WG	1
						Check air filter indicator	-	1
	O			2	Hydraulic fluid reservoir	Check fluid level	HYDO	1

The table below indicates the *Person Responsible* for each procedure.

O = Operator.
T = Trained Personnel.

 = Indicates unique maintenance schedule for machines equipped with HEPA filtration system.

Interval	Person Resp.	HEPA	Non-HEPA	Key	Description	Procedure	Lube/ Fluid	No. of Service Points
Daily/ 8 Hours	O			3	Hopper dust filter	Shake to clean	–	1
	O		*	3	Hopper	Inspect / Clean	–	1
	O	*		3	Hopper	Clean / Rinse	–	1
	O			4	Main brush compartment skirts	Check for damage, wear, and adjustment	–	All
	O			5	Hopper skirts	Check for damage, wear, and adjustment	–	All
	O			6	Main brush	Check for damage and wear	–	1
	O			7	Side brush	Check for damage and wear	–	1
	O			19	Dry dust control skirts (Option)	Inspect for wear and damage	–	1
	O	*		16	Cyclonic chamber and dust tray flaps	Check for wear, damage, and ensure flaps are fully open and free of debris buildup	–	All
50 Hours	O	*		3	Hopper dust filter & seals	Inspect for buildup of dust and lint/fiber on dirty side of filter. Inspect for damaged seals and dust leaks across seals	–	1
	O	*		3	Dust filter cover	Inspect for traces of dust build up inside cover	–	1
						Inspect for damaged seal and dust leaks across seal	–	1
	O	*		16	Upper cyclone chamber	Clean	–	1
	T	*		1	Engine compartment	Clean	–	1
	O			6	Main brush	Rotate end-for-end	–	1

MAINTENANCE

The table below indicates the *Person Responsible* for each procedure.

O = Operator.

T = Trained Personnel.

 = Indicates unique maintenance schedule for machines equipped with HEPA filtration system.

Interval	Person Resp.	HEPA	Non-HEPA	Key	Description	Procedure	Lube/ Fluid	No. of Service Points
50 Hours	T			6	Main brush	Check brush pattern and adjust if needed	-	1
	T			8	Rear wheel	Torque wheel nuts (after initial 50 hours only)	-	1
	T			9	Battery	Clean and tighten battery cable connections (after initial 50 hours only)	-	1
	T			1	Engine	Check belt tension	-	1
	O			17	Wet side brush dust control spray nozzle (option)	Check pattern	-	2 (4)
100 Hours	T			1	Engine	Change oil and filter	EO	1
						Drain LPG vaporizer oil buildup	-	1
					Engine, GM (S/N 000000-005699)	Drain oil from electronic pressure regulator (EPR)	-	1
	T		*	3	Hopper dust filter	Check for damage, clean or replace	-	1
	O		*	16	Upper cyclone chamber	Clean	-	1
	O		*	3	Dust filter cover	Inspect for damaged seal and dust leaks across seal	-	1
	T		*	16	Cyclone and filter housing	Clean	-	All
	T		*	16	Cyclonic chamber and dust tray flaps	Check for wear, damage, and ensure flaps are fully open and free of debris buildup	-	All
	T			10	Radiator	Clean core exterior	-	1
	T			10	Hydraulic cooler	Clean core exterior	HYDO	1

The table below indicates the *Person Responsible* for each procedure.

O = Operator.
T = Trained Personnel.

 = Indicates unique maintenance schedule for machines equipped with HEPA filtration system.

Interval	Person Resp.	HEPA	Non-HEPA	Key	Description	Procedure	Lube/ Fluid	No. of Service Points
100 Hours	O			8	Rear tire	Check pressure	-	1
	O			-	Seals	Check for damage or wear	-	All
200 Hours	T			10	Radiator hoses and clamps	Check for tightness and wear	-	All
	T	*		16	Lower cyclone chamber	Clean	-	All
	T	*		20	Perma-Filter	Inspect condition and clean	-	All
	T			11	Brake pedal	Check adjustment	-	1
	T			12	Rear wheel support bearings	Lubricate	SPL	2
	T			12	Steering cylinder bearings	Lubricate	SPL	1
	T			13	Hopper lift arm bearings	Lubricate	SPL	2
	T			14	Side brush guard	Rotate 90°	-	1
	O			18	Wet side brush dust control filter screen (option)	Clean	-	1
400 Hours	T			1	Engine, GM (S/N 000000-005699)	Clean and re-gap or replace spark plugs	-	4
					Engine	Replace fuel filter (Gas/LPG)	-	1
	T			15	Front wheels	Adjust and repack bearings	SPL	2
	O	*		21	HEPA filter housing (Option)	Inspect and clean		1
800 Hours	T			2	Hydraulic fluid reservoir	Replace filler cap	-	1
	T			1	Engine, GM (S/N 000000-005699)	Check timing belt	-	1
	T			-	Hydraulic hoses	Check for wear and damage	-	All

MAINTENANCE

The table below indicates the *Person Responsible* for each procedure.

O = Operator.

T = Trained Personnel.

 = Indicates unique maintenance schedule for machines equipped with HEPA filtration system.

Interval	Person Resp.	HEPA	Non-HEPA	Key	Description	Procedure	Lube/ Fluid	No. of Service Points
800 Hours	T			10	Cooling system	Flush	WG	1
	T			8	Propelling motor	Torque shaft nut	-	1
	T			8	Rear wheel	Torque wheel nuts	-	1
	T			9	Battery	Clean and tighten battery cable connections	-	1
1000 Hours	T			1	Engine, Mitsubishi (S/N 005700-)	Replace spark plugs	-	4
	T			1	Engine	Inspect PCV system	-	1
	T			1	Radiator hoses	Check for cracks or deterioration	-	2
1200 Hours	T			2	Hydraulic fluid filter	* Change filter element	-	All
2000 Hours	T			1	Engine, GM (S/N 000000-005699)	Replace timing belt		1
2400 Hours	T			2	Hydraulic fluid reservoir	* Replace suction strainer	-	1
						* Change hydraulic fluid	HYDO	1
5000 Hours	T			1	Engine, Mitsubishi (S/N 005700-)	Replace camshaft and balance shaft belts	-	2

NOTE: Change the hydraulic fluid, filter, and suction strainer, indicated (*), after every 800 hours for machines NOT originally equipped with **Tennant True** premium hydraulic fluid. (See Hydraulics section).

LUBRICANT/FLUID

EO Engine oil, 5W30 SAE-SG/SH only.

HYDO . **Tennant True** premium hydraulic fluid or equivalent

WG . . . Water and ethylene glycol anti-freeze, -34° C (-30° F)

SPL . . . Special lubricant, Lubriplate EMB grease (Tennant part number 01433-1)

NOTE: More frequent maintenance intervals may be required in extremely dusty conditions.

LUBRICATION

FOR SAFETY: Before leaving or servicing machine, stop on level surface, set parking brake, turn off machine, and remove key.

ENGINE OIL

Check the engine oil level daily. Change the oil and oil filter after every 100 hours of operation.



Fill the engine with oil until the oil is between the indicator marks on the dipstick. **DO NOT** fill past the top indicator mark.

The engine oil capacity for **GM engines** (machines serial number 005699 and below) is 3.5 L (3.7 qt) with oil filter.

The engine oil capacity for **Mitsubishi engines** (machines serial number 005700 and above) is 4.7 L (5 qt) with oil filter.

REAR WHEEL SUPPORT

Lubricate the rear wheel support bearings after every 200 hours of operation.

**STEERING CYLINDER BEARING**

Lubricate the steering cylinder after every 200 hours of operation.

**HOPPER LIFT ARM BEARINGS**

Lubricate the hopper lift arm bearings after every 200 hours of operation.

**FRONT WHEEL BEARINGS**

Repack and adjust the front wheel bearings every 400 hours of operation.



MAINTENANCE

HYDRAULICS

FOR SAFETY: Before leaving or servicing machine, stop on level surface, set parking brake, turn off machine, and remove key.

Check the hydraulic fluid level at operating temperature daily. The hopper must be down when checking hydraulic fluid level.

Machines (S/N 00000–007684) have a filler cap with a fluid level dipstick. The hydraulic fluid level should be between the full and add markings on the dipstick.



Machines (S/N 007685–) have a fluid level gauge on the hydraulic tank. The hydraulic fluid level should be between the two lines on the hydraulic gauge.

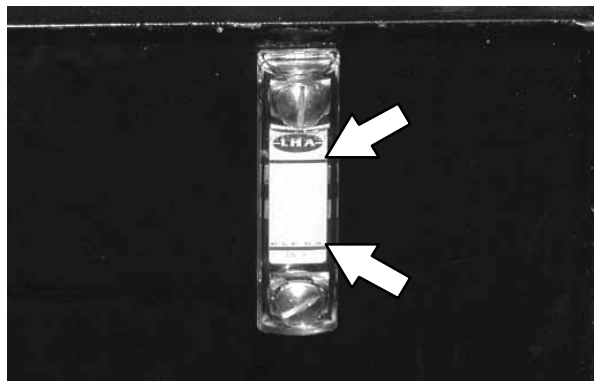

A filler cap is mounted on top of the reservoir. It has a built-in breather and fluid level dipstick. Replace the cap after every 800 hours of operation.

Lubricate the filler cap gasket with a film of hydraulic fluid before putting the cap back on the reservoir.

ATTENTION! Do not overfill the hydraulic fluid reservoir or operate the machine with a low level of hydraulic fluid in the reservoir. Damage to the machine hydraulic system may result.

Drain and refill the hydraulic fluid reservoir with new **Tennant True** premium hydraulic fluid after every 2400 hours of operation. Machines have a blue colored drop (left photo) on the hydraulic fluid label if originally equipped with **Tennant True** premium hydraulic fluid.

WARNING: Burn hazard. Hot surface. Do NOT touch.



Tennant True Fluid



Previous Fluid

*NOTE: Change the hydraulic fluid, filter, and suction strainer after every 800 hours for ALL machines that have NOT consistently used **Tennant True** premium hydraulic fluid or equivalent.*

The reservoir has a built-in strainer outlet that filters hydraulic fluid before it enters the system. Replace the strainer after every 2400 hours of operation.

Replace the hydraulic fluid filter after every 1200 hours of operation or if the hydraulic reservoir gauge is in the yellow/red zone when the reservoir hydraulic fluid is approximately 32°C (90° F).



HYDRAULIC FLUID

There are three fluids available for different ambient air temperature ranges:

Tennant <i>True</i> premium hydraulic fluid (Extended Life)			
Part Number	Capacity	ISO Grade Viscosity Index (VI)	Ambient Air Temperature Ranges
1057710	3.8 L (1 gal)	ISO 100 VI 126 or higher	19° C (65° F) or higher
1057711	19 L (5 gal)		
1069019	3.8 L (1 gal)	ISO 68 VI 155 or higher	7 to 43° C (45 to 110° F)
1069020	19 L (5 gal)		
1057707	3.8 L (1 gal)	ISO 32 VI 163 or higher	16° C (60° F) or lower
1057708	19 L (5 gal)		

If using a locally-available hydraulic fluid, be sure the specifications match Tennant hydraulic fluid specifications. Substitute fluids can cause premature failure of hydraulic components.

ATTENTION! Hydraulic components depend on system hydraulic fluid for internal lubrication. Malfunctions, accelerated wear, and damage will result if dirt or other contaminants enter the hydraulic system.

HYDRAULIC HOSES

Check the hydraulic hoses after every 800 hours of operation for wear or damage.

FOR SAFETY: When servicing machine, use cardboard to locate leaking hydraulic fluid under pressure.

High pressure fluid escaping from a very small hole can almost be invisible, and can cause injury.

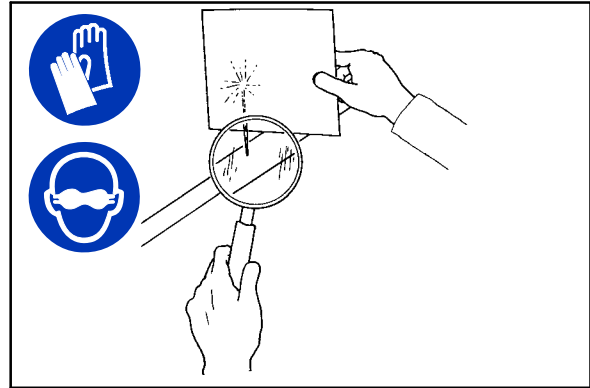

00002

Contact appropriate personnel if a leak is discovered.

ATTENTION: Only use TENNANT supplied hydraulic hoses or equivalent rated hydraulic hoses.

MAINTENANCE

ENGINE

FOR SAFETY: Before leaving or servicing machine, stop on level surface, set parking brake, turn off machine, and remove key.

COOLING SYSTEM

FOR SAFETY: When servicing machine, avoid contact with hot engine coolant. Do not remove cap from radiator when engine is hot. Allow engine to cool.

Check the coolant level in the reservoir daily. The coolant level must be between the indicator marks when the engine is cold.



FOR SAFETY: When servicing machine, do not remove cap from radiator when engine is hot. Allow engine to cool.

Refer to the coolant manufacturer for water/coolant mixing instructions.

Flush the radiator and the cooling system after every 800 hours of operation.

The cooling system must be completely filled with coolant to keep the engine from overheating. When filling the cooling system, open the drain cocks to bleed the air from the system for machines serial number 002003 and below. (Machines serial number 002004 and above do not have drain cocks).

Location of drain cock on LPG machines for machines serial number 002003 and below.



Location of drain cock on gasoline machines for machines serial number 002003 and below.



Check the radiator hoses and clamps after every 200 hours of operation. Tighten loose clamps. Replace damaged hoses and clamps.

Check the radiator hoses for cracks and deterioration after every 1000 hours of operation.



Check the radiator core exterior and hydraulic cooler fins for debris after every 100 hours of operation. Blow or rinse (with low pressure air or water) all dust through the grille and radiator fins, in the opposite direction of normal air flow. Be careful to not bend the cooling fins when cleaning. Clean thoroughly to prevent the fins from becoming encrusted with dust. To avoid cracking the radiator, allow the radiator and cooler fins to cool before cleaning.

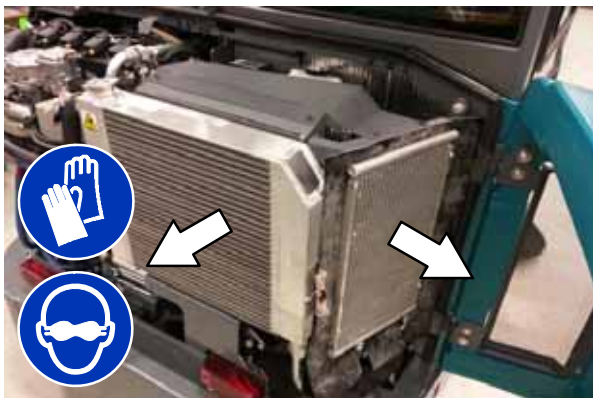

CLEAN THE ENGINE AND ENGINE COMPARTMENT

Clean the engine and engine compartment after every 50 hours of operation on machines equipped with HEPA.

FOR SAFETY: When servicing machine, avoid contact with hot engine coolant. Do not remove cap from radiator when engine is hot. Allow engine to cool.



MAINTENANCE

AIR FILTER INDICATOR

Check the indicator daily. The indicator red line will move as the air filter element fills with dirt. Do not replace the air filter element until the red line reaches 5 kPa (20 in H₂O) and the "SERVICE WHEN RED" window is filled with red. The engine must be running to get an accurate air indicator reading.

FOR SAFETY: When servicing machine, avoid moving parts. Do not wear loose clothing, jewelry and secure long hair.

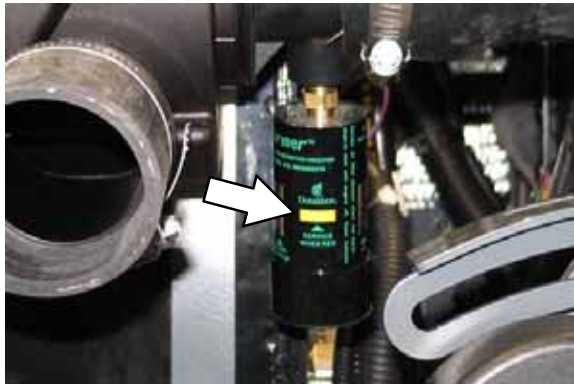

AIR FILTER

FOR SAFETY: Before leaving or servicing machine, stop on level surface, set parking brake, turn off machine, and remove key.

The engine air filter housing is located in front of the engine compartment inside the left side shroud door.

Replace the air filter element when the air filter indicator shows restriction in the air intake system or the filter element is damaged. Refer to *AIR FILTER INDICATOR*.



Remove the filter element. Carefully clean the end cap and the interior of the housing with a damp cloth. Clean the housing sealing surfaces.



Replace the safety filter element after the primary has been changed three times. Do not remove the safety filter element from the housing unless it is restricting air flow.



Install the filter element into the air filter housing and reinstall the dust cap with the water drain pointing down.



Push the reset button on the end of the indicator to reset the air filter indicator after replacing the air filter element.

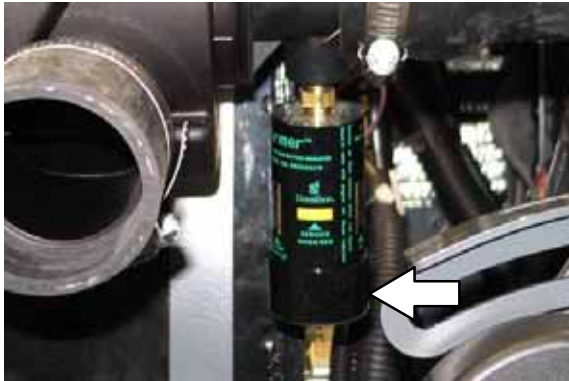

FUEL FILTER (Gasoline)

Replace the gasoline fuel filter after every 400 hours of operation.

FOR SAFETY: When servicing machine, keep flames and sparks away from fuel system service area. Keep area well ventilated.

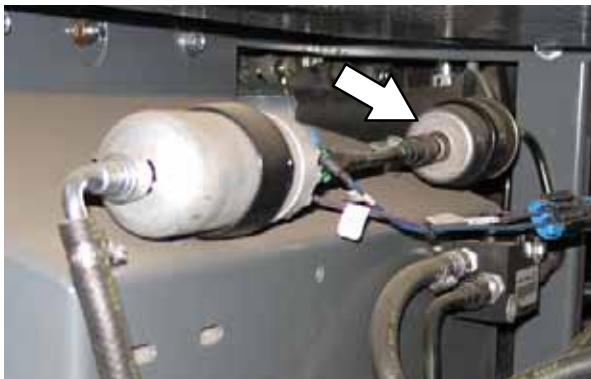

FUEL FILTER (LPG)

NOTE: Close the LPG tank service valve and operate the engine until it stops from lack of fuel before working on the LPG fuel system.

Replace the LPG fuel filter after every 400 hours of operation.

Disassemble the fuel lock off valve to access the LPG fuel filter.

FOR SAFETY: When servicing machine, keep flames and sparks away from fuel system service area. Keep area well ventilated.



MAINTENANCE

ELECTRONIC PRESSURE REGULATOR (LPG) (S/N 000000 – 005699)

Remove the sensor and drain the oil from the LPG electronic pressure regulator (EPR) after every 100 hours of operation.

FOR SAFETY: When servicing machine, keep flames and sparks away from fuel system service area. Keep area well ventilated.

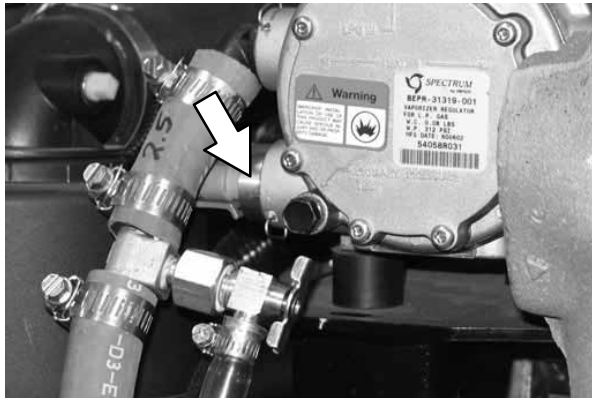

LPG VAPORIZER

Drain oil buildup in the LPG vaporizer after every 100 hours of operation.

FOR SAFETY: When servicing machine, keep flames and sparks away from fuel system service area. Keep area well ventilated.



SPARK PLUGS – GM ENGINES (S/N 000000 – 005699)

Clean or replace, and set the gap of the spark plugs after every 400 hours of operation. The proper spark plug gap is 1 mm (0.042 in).

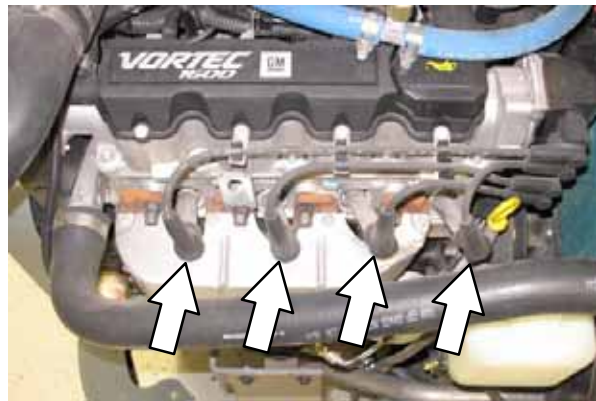

SPARK PLUGS – MITSUBISHI ENGINES (S/N 005700 –)

Replace the spark plugs after every 1000 hours of operation.



ENGINE BELT

Check the belt tension after every 50 hours of operation. Adjust tension as necessary. Proper belt tension is 13 mm (0.50 in) from a force of 4 to 5 kg (8 to 10 lb) applied at the mid-point of the longest span.

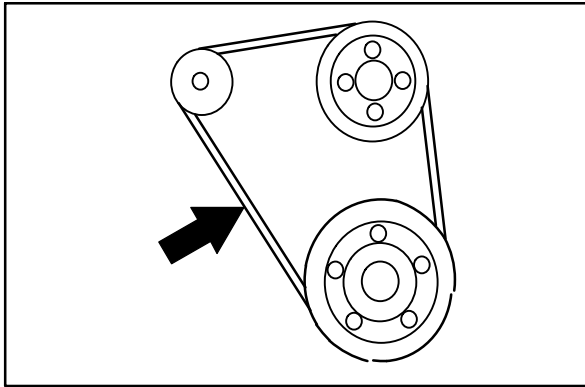

WARNING: Moving belt and fan. Keep away.

**TIMING BELT – GM ENGINES
(S/N 000000 – 005699)**

Check the timing belt after every 800 hours of operation.

Replace the timing belt after every 2000 hours of operation.

**CAMSHAFT AND BALANCE SHAFT BELTS –
MITSUBISHI ENGINES (S/N 005700 –)**

Replace the camshaft and balance shaft belts after every 5000 hours of operation.

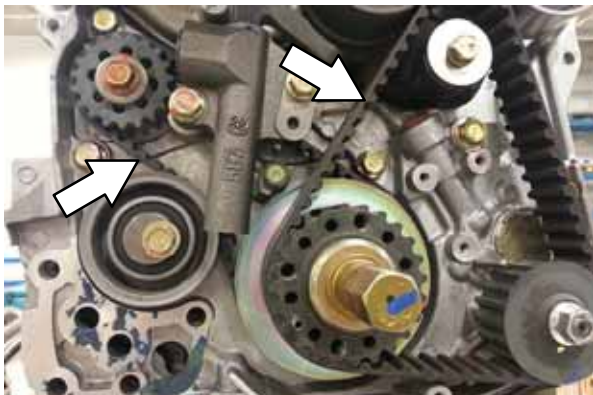

PCV SYSTEM

Inspect the PCV system after every 100 hours of operation.



BATTERY

Clean and tighten the battery connections after the first 50 hours of operation and after every 800 hours after that. Do not remove the vent plugs from the battery or add water to the battery.

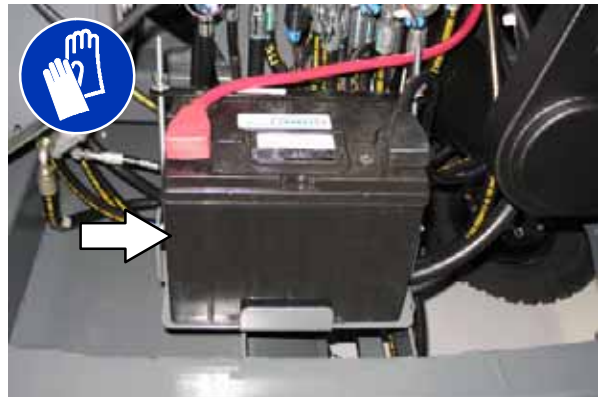

FOR SAFETY: When servicing machine, avoid contact with battery acid.

MAINTENANCE

FUSES AND RELAYS

RELAY PANEL FUSES AND RELAYS

Remove the relay panel cover to access fuses and relays. Always replace a fuse with a fuse of the same amperage. Extra 15 Amp fuses are provided inside the relay panel drawer on the relay panel.



Refer to the diagram below for locations of the fuses and relays on the relay panel.

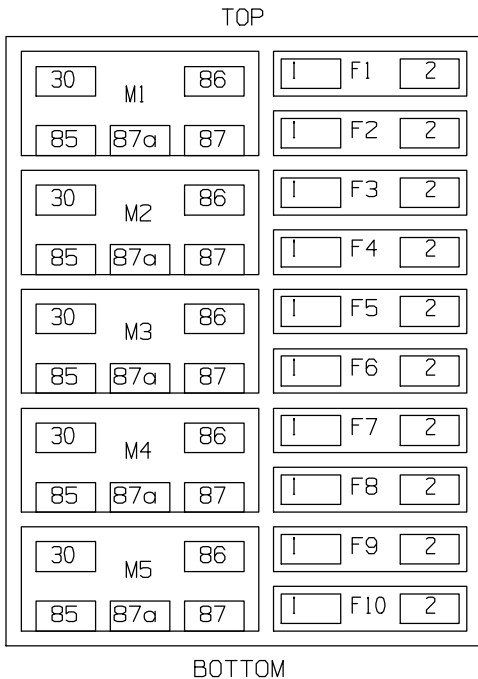

Refer to the tables below for the fuses and circuits protected.

S30		
Fuse	Rating	Circuit Protected
FU1	15 A	Horn
FU2	15 A	Key Switch, Engine, Instrumentation
FU3	15 A	Turn Signals, 4-Way Flashers
FU4	15 A	Extra Fused, Switched B+
FU5	15 A	Main Brush Valves, Side Brush Valves
FU6	15 A	Hopper Valves
FU7	15 A	Lights, Backup Alarm
FU8	15 A	Extra Fused B+
FU9	15 A	Shaker, Vacuum Fan Valve
FU10	15 A	Not Used
FU11	60 A	Main Power Fuse, In Line, In Main Harness
FU12	60 A	Cab Power (Optional)
FU13	40 A	Not Used
FU14	60 A	Cab Power (Optional)

S30 XP and X4		
Fuse	Rating	Circuit Protected
FU1	15 A	Horn
FU2	15 A	Key Switch, Engine, Instrumentation
FU3	15 A	Turn Signals, 4-Way Flashers, Shaker
FU4	15 A	Control Board
FU5	15 A	Main Brush Valves, Side Brush Valves
FU6	15 A	Hopper Valves, Vacuum Fan Valves
FU7	15 A	Lights, Backup Alarm
FU8	15 A	Extra Fused B+
FU9	15 A	Extra Switched, Fused B+
FU10	15 A	Not Used
FU11	60 A	Main Power Fuse, In Line, In Main Harness
FU12	60 A	Cab Power (Optional)
FU13	40 A	Not Used
FU14	60 A	Cab Power (Optional)

NOTE: Always replace a fuse with a fuse of the same amperage.

Refer to the tables below for the *relays* and circuits controlled.

S30		
Relay	Rating	Circuit Controlled
M1	12 VDC, 40 A	Horn
M2	12 VDC, 40 A	Auxiliary 1
M3	12 VDC, 40 A	Shaker
M4	12 VDC, 40 A	Main Brush Valves, Side Brush Valves
M5	12 VDC, 40 A	Auxiliary 2

S30 XP and X4		
Relay	Rating	Circuit Controlled
M1	12 VDC, 40 A	Horn
M2	12 VDC, 40 A	Auxiliary 1
M3	12 VDC, 40 A	Shaker
M4	12 VDC, 40 A	Not Used
M5	12 VDC, 40 A	Auxiliary 2

ENGINE HARNESS FUSES AND RELAYS

The *engine harness fuses and relays* are located in the fuse box inside the engine compartment. Refer to the fuse box cover for locations of engine harness fuses and relays.



NOTE: Always replace a fuse with a fuse of the same amperage.

CAB FUSES (CAB OPTION)

The *cab fuses* are located in the fuse box inside the cab. Remove the fuse cover to access the fuses.



Refer to the table below for the *fuses* and circuits controlled.

Fuse	Rating	Circuit Protected
FU1	5 A	Lights
FU2	5 A	Wiper
FU3	20 A	Air Conditioner
FU4	2 A	Heat

NOTE: Always replace a fuse with a fuse of the same amperage.

HEPA (HIGH EFFICIENCY PARTICULATE ARRESTANCE) FILTRATION SYSTEM (OPTION)

The High Efficiency Particulate Arrestance (HEPA) filtration system is a dry sweeping system consisting of the dry dust control, cyclone chamber, and HEPA filter box. The filters, skirts and seals in each of these areas are critical in the performance of the HEPA system.

The optional HEPA filtration system helps clean in fine dust environments.

NOTE: While cleaning or performing any type of maintenance on HEPA filter systems, refer to company or local regulations regarding safety requirements.

HOPPER

Inspect and clean the hopper daily.

1. Turn on the machine, raise the hopper approximately 3–4 in. (76.2–101.6 mm), open hopper dump door, and turn off the machine.



WARNING: Lift arm pinch point. Stay clear of hopper lift arms.

2. Open the hopper access door.



3. Clean any debris from hopper.
4. HEPA Machines: Use a garden hose to clean the hopper out through the hopper access door.
5. Close and secure the hopper access door.
6. Close and secure the hopper cover.
7. Turn on the machine and lower the hopper.
8. Allow hopper to fully dry before using machine.

REMOVING AND INSPECTING THE DUST FILTER (S/N 000000 – 006500)

Shake the dust filter at the end of every shift and before removing the filter from the machine. Inspect and clean the filter after every 100 hours of operation. Replace damaged dust filters.

NOTE: Clean the filter more often if used in extremely dusty conditions.

FOR SAFETY: Before leaving or servicing machine, stop on level surface, set parking brake, turn off machine, and remove key.

1. Open the top cover and side shroud.
2. Remove the filter shaker assembly from the filter housing.

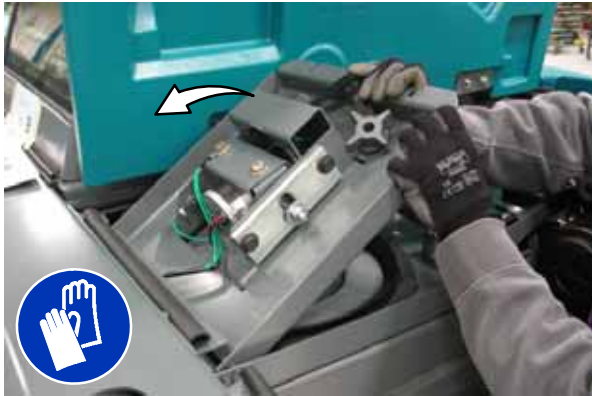

3. Remove the dust filter from the filter housing.



4. Clean or discard the dust filter element. Refer to *CLEANING THE DUST FILTER*.
5. Insert the dust filter into the filter housing and reinstall the removed parts.



6. Close the side shroud and top cover.

MAINTENANCE

REMOVING AND INSPECTING THE DUST FILTER (S/N 006501 -)

Shake the dust filter after the hopper is emptied and / or when the primary filter shaker light is illuminated.

Inspect and clean the hopper dust filter and filter cover after every 100 hours of machine operation or 50 hours on machines equipped with HEPA. Replace damaged dust filters.

FOR SAFETY: Before leaving or servicing machine, stop on level surface, set parking brake, turn off machine, and remove key.

NOTE: Clean the filter more often if used in extremely dusty conditions.

1. Press the filter shaker button to shake dust and debris from the primary dust filter.
2. Unlatch and open the hopper cover. Support the hopper cover open with the hopper cover prop rod.



3. Completely loosen the two wing nuts securing the dust filter cover to the upper cyclone chamber.



4. Disconnect the vacuum hose from the dust filter cover.



5. Remove the dust filter cover.



6. Inspect dust filter cover seal for proper seal, damage, and dust / debris build up. Clean all dust and debris from dust filter cover.

NOTE: If dust is detected on the inside of the cover, check dust filter seal height.



CHECK DUST FILTER SEAL HEIGHT (S/N 006501 –)

If excessive dust occurs while sweeping, check the dust filter seal height. The distance from the shaker bracket to the top of the compartment should be 9.25 in. (235 mm). Adjust if necessary.

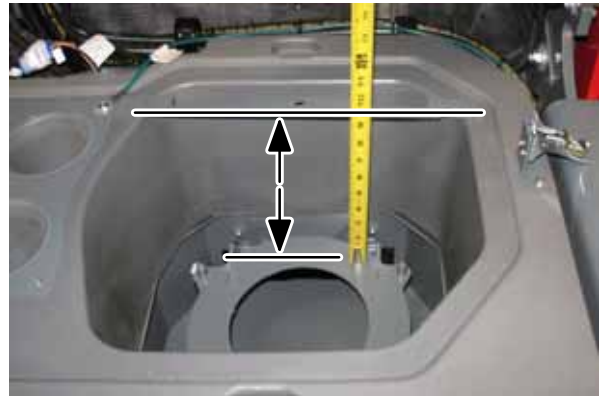

7. Use both hands to firmly grasp the dust filter and carefully lift the dust filter from the dust filter compartment. **DO NOT** use the seal to lift the dust filter from the dust filter compartment.



8. Clean or discard the dust filter element. Refer to *CLEANING THE DUST FILTER*.
9. Clean the upper cyclone chamber. Refer to *CLEANING THE UPPER CYCLONE CHAMBER*.
10. Reinstall the dust filter.
11. Reinstall the dust filter cover.
12. Close the hopper cover.

MAINTENANCE

CLEANING THE DUST FILTER

MACHINES WITH STANDARD FILTRATION SYSTEM

Use one of the following methods to clean the dust filter:

SHAKING–Press the *filter shaker switch*.

TAPPING–Tap the filter gently on a flat surface. **Do not damage the edges of the filter.** The filter will not seal properly if the edges of the filter are damaged.

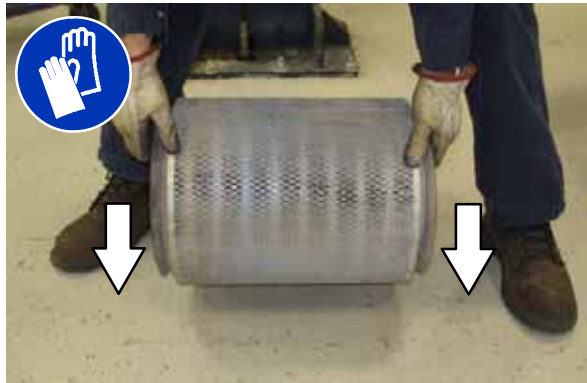

AIR–Always wear eye protection when using compressed air. Blow air through the center of the filter and out toward the exterior. Never use more than 550 kPa (80 psi) of air pressure with a nozzle no smaller than 3 mm (0.13 in) and never hold the nozzle closer than 50 mm (2 in) to the filter.



MACHINES EQUIPPED WITH HEPA FILTRATION SYSTEM

Use one of the following methods to clean the dust filter on machines equipped with HEPA.

SHAKING–Press the *filter shaker switch*.

TAPPING–Place the filter into a plastic bag and gently tap the filter gently on a flat surface. **Do not damage the edges of the filter.** The filter will not seal properly if the edges of the filter are damaged.



DO NOT use air to clean the dust filter.



Inspect the dust filter seals for proper seal and damage. Dust build up on the seal surfaces means dust is getting past the dust filter, significantly reducing the HEPA filter life.

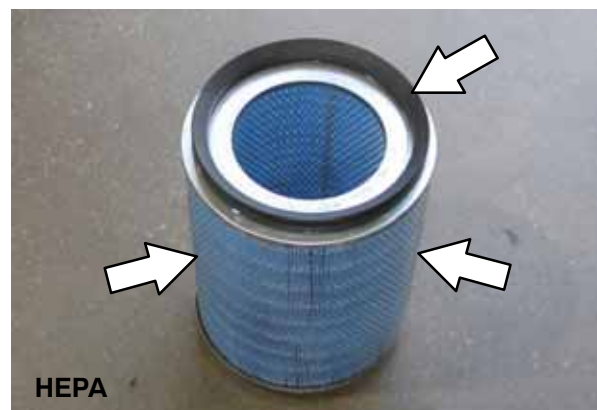

**CLEANING THE CYCLONE ASSEMBLY
(S/N 006501 -)**

CLEANING THE UPPER CYCLONE CHAMBER

Clean the upper cyclone chamber and filter housing every 100 hours of machine operation or 50 hours on machines equipped with HEPA.

FOR SAFETY: Before leaving or servicing machine, stop on level surface, set parking brake, turn off machine, and remove key.

1. Clean dust and debris from the dust filter housing.



2. Open the rear cyclone cover access port to empty dust and debris from the cyclone cover.

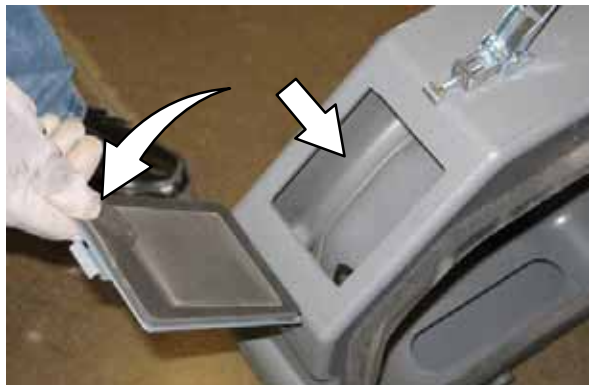

3. Machines (S/N 008826 -), open the front clean out door on the upper cyclone chamber and clean.



4. HEPA Machines: Use a HEPA certified vacuum to clean dust and debris from the interior of the upper cyclone chamber.

NOTE: A HEPA certified vacuum is recommended to clean the HEPA filter system. Refer to company or local regulations regarding safety requirements.



5. HEPA Machines: Use a HEPA certified vacuum to clean the slots located at the top of the dust filter compartment.

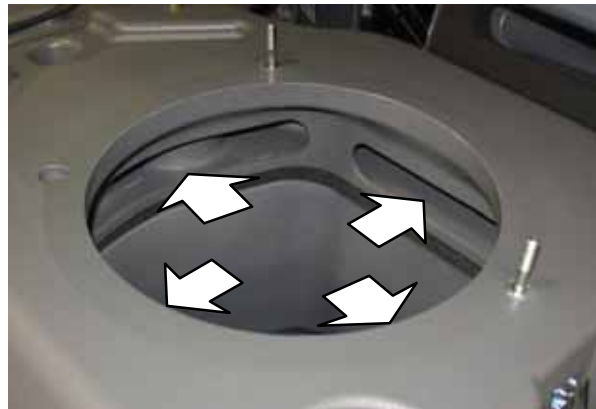

6. Close and secure the upper cyclone chamber access door when finished cleaning the interior of the upper cyclone chamber.

MAINTENANCE

CLEANING THE LOWER CYCLONE CHAMBER

Clean the cyclones after every 100 hours of operation.



CLEANING THE LOWER CYCLONE CHAMBER (HEPA OPTION)

Machines equipped with HEPA require additional cleaning of the lower cyclone chamber and Perma-Filter. Clean the lower cyclone chamber and Perma-Filter every 200 hours of operation.

1. Disconnect the vacuum hose from the upper cyclone chamber.



2. Loosen clamps securing the upper cyclone chamber and then remove it from the hopper.



3. Disconnect the main wire harness from the filter shaker assembly jumper cable.



4. Disconnect the ground wire from the lower cyclone chamber.

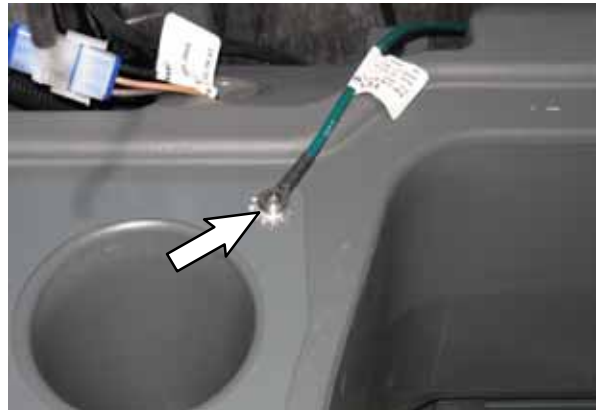

5. Disconnect the jumper harness from the filter shaker assembly.



6. Remove the filter shaker assembly.



10. Open the hopper access door.



7. Loosen the three clamps securing the lower cyclone chamber to the hopper.



11. Clean all dirt and debris from the hopper.



8. With the help of an assistant, lift the lower cyclone chamber and remove it from the hopper.

9. Turn on the machine, raise the hopper approximately 3–4 in. (76.2–101.6 mm), open hopper dump door, and turn off the machine.



12. Use a garden hose to clean out the filter compartment and lower cyclone compartment.

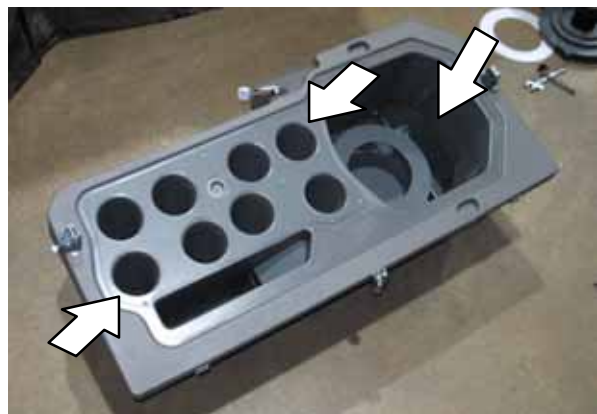

MAINTENANCE

13. Inspect cyclone Perma-Filter inside the lower cyclone compartment for debris.



14. Clean the cyclone Perma-Filter using a garden hose.

15. Reinstall the cyclone Perma-Filter.

16. Inspect the lower cyclone chamber flaps and ensure they open and close completely. Remove any excessive dust buildup on the flaps.

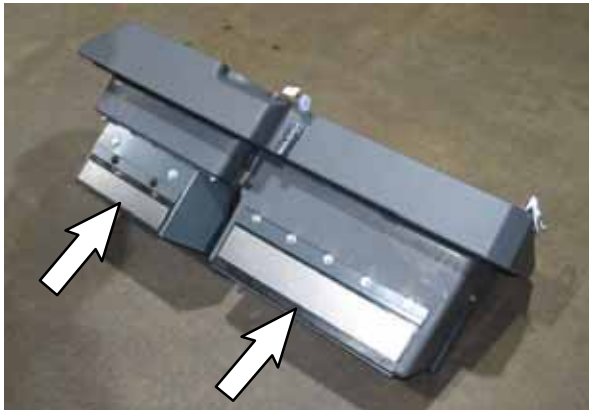

17. Allow the lower cyclone compartment / dust filter compartment / Perma-Filter compartment to completely dry.

18. Turn on the machine, lower the hopper, and turn off the machine.

19. With the help of an assistant, reinstall the lower cyclone chamber into the hopper. Ensure no hoses or harness leads are pinched between the bottom of the lower cyclone chamber and the top of the hopper.

20. Tighten the three clamps securing the lower cyclone chamber to the hopper.

21. Reinstall the upper cyclone assembly, dust filter, and dust filter cover in reverse order of disassembly.

CYCLONE PERMA-FILTER (S/N 006501 -)

Clean heavy or wet dust and excess debris from the cyclone Perma-Filter as necessary. Check the cyclone Perma-Filter for damage every 100 hours of operation.



INSPECT AND CLEAN THE HEPA FILTER HOUSING (OPTION)

Inspect and clean the HEPA filter housing after every 400 hours of operation or when the HEPA light is illuminated. When the light is illuminated, check the system for blockages, stuck flaps, or anything else that may be restricting the flow to the HEPA filter. Replace the HEPA filter if it is plugged and / or damaged.



1. Open the top shroud and side shroud to access the HEPA filter compartment.



2. Loosen clamps securing the cover to the HEPA filter assembly and remove the cover from the HEPA filter assembly.



3. Remove the HEPA filter from the HEPA filter compartment.



4. Inspect the HEPA filter and seals for dust, debris, and damage. Replace the HEPA filter if filter or filter seals are damaged.



5. Use a HEPA certified vacuum to clean the HEPA filter compartment and the HEPA filter housing inlet hose.

NOTE: A HEPA certified vacuum is recommended to clean the HEPA filter system. Refer to company or local regulations regarding safety requirements.

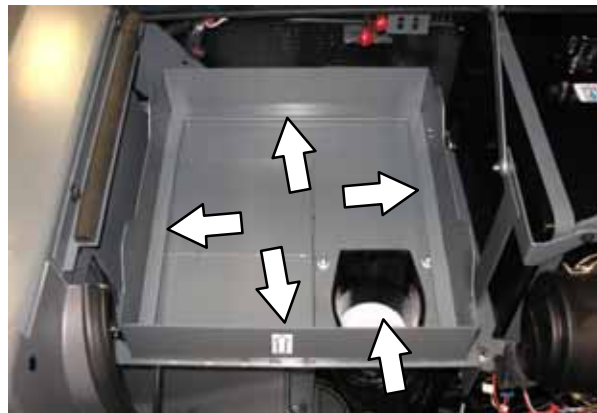

MAINTENANCE

6. Reinstall the HEPA filter into the HEPA filter assembly. Be sure the arrow on the HEPA filter label is pointing up.



7. Reinstall the cover onto the HEPA filter assembly.
8. Inspect the HEPA filter assembly seal and the top cover HEPA seal for dust, debris, and damage. Replace damaged or worn seals.

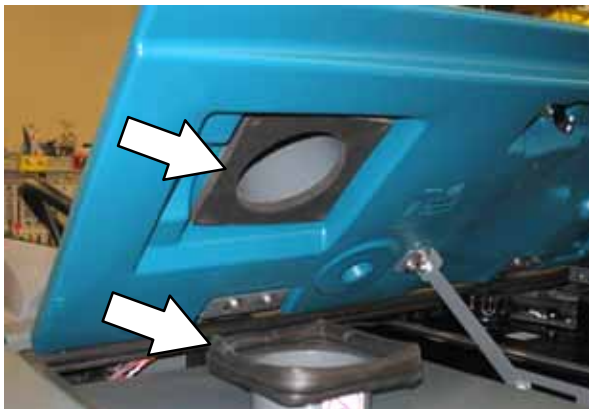

9. Ensure HEPA vent cover freely opens and closes with no binding or sticking.

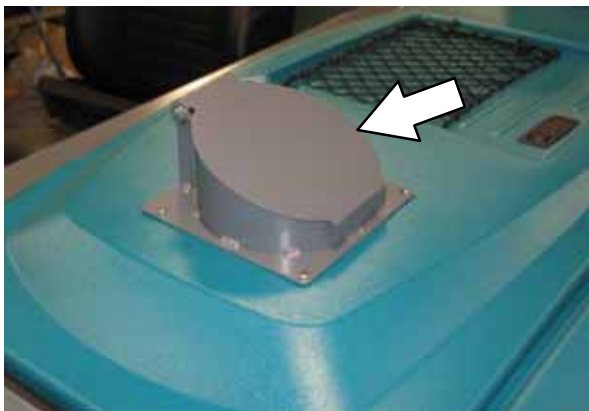

MAIN BRUSH

FOR SAFETY: Before leaving or servicing machine, stop on level surface, set parking brake, turn off machine, and remove key.

Check the brush daily for wear or damage. Remove any string or wire tangled on the main brush, main brush drive hub, or main brush idler hub.



Rotate the brush end-for-end after every 50 hours of operation, for maximum brush life and best sweeping performance. Refer to *REPLACING OR ROTATING THE MAIN BRUSH*.

Replace the main brush when it no longer cleans effectively.

REPLACING OR ROTATING THE MAIN BRUSH

1. Raise the brush head.

FOR SAFETY: Before leaving or servicing machine, stop on level surface, set parking brake, turn off machine, and remove key.

2. Open the right side main brush access door.



3. Unlatch and remove the brush idler plate.

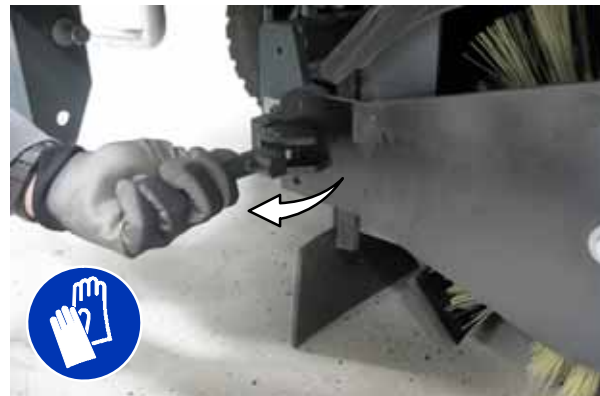

MAINTENANCE

4. Pull the main brush from the main brush compartment.



5. Replace or rotate the main brush end-for-end.
6. Slide the brush into the brush compartment and all the way onto the drive plug.
7. Reinstall the brush idler plate.



8. Close the right side main brush access door.
9. Check and adjust the brush pattern if needed after replacing or rotating it. Refer to *CHECKING THE MAIN BRUSH PATTERN*.

CHECKING THE MAIN BRUSH PATTERN

1. Apply chalk, or a similar marking material, to a smooth and level section of the floor.

NOTE: If chalk or other material is not available, allow the brush to spin on the floor for two minutes. A polish mark will remain on the floor.

2. Lower the main brush onto the chalked area and hold it there for 15 to 20 seconds without moving the machine.
3. Raise the brush and drive the machine from the chalked area. The brush pattern should be 50 to 75 mm (2.0 to 3.0 in) across the entire length of the brush. Refer to *ADJUSTING THE MAIN BRUSH WIDTH*.

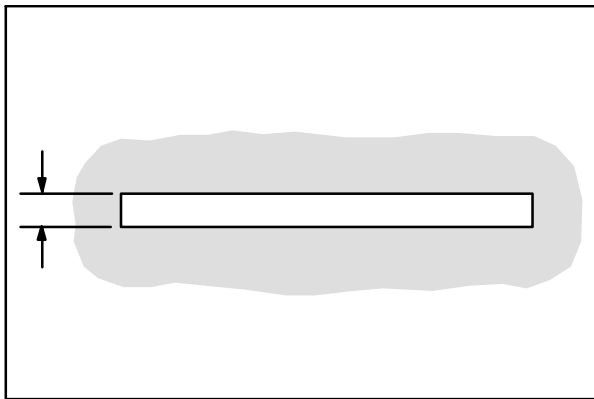

00582

4. If the brush pattern is tapered, see *ADJUSTING THE MAIN BRUSH TAPER* section of this manual.

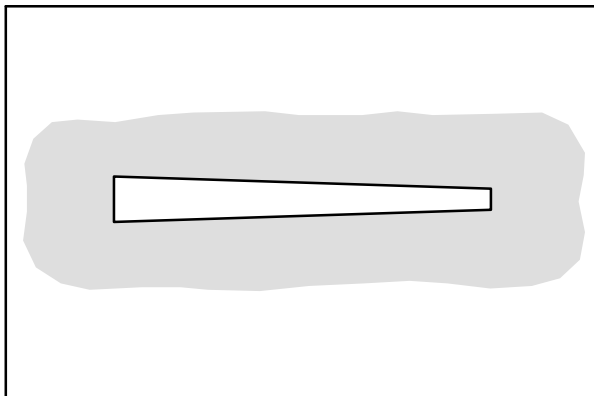

00601

ADJUSTING THE MAIN BRUSH TAPER

FOR SAFETY: Before leaving or servicing machine, stop on level surface, set parking brake, turn off machine, and remove key.

1. Loosen the shaft bearing bracket mounting bolts.

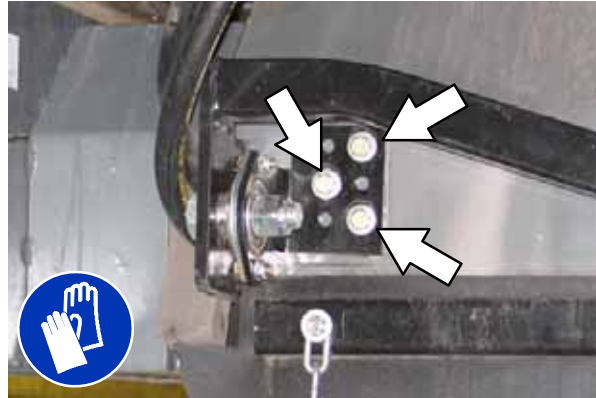

2. Move the bracket up or down in the slots and tighten the mounting bolts.
3. Check the main brush pattern and readjust as necessary. Maximum taper is 13 mm (0.5 in). Set the main brush adjustment knob pointer to the same color band as the brush idler plate.

MAINTENANCE

ADJUSTING THE MAIN BRUSH WIDTH

FOR SAFETY: Before leaving or servicing machine, stop on level surface, set parking brake, turn off machine, and remove key.

1. Compare the length of the main brush bristles with the color band on the brush idler plate.



2. Loosen the main brush adjustment knob and slide the pointer so it matches the color band on the brush idler plate. Retighten the knob.

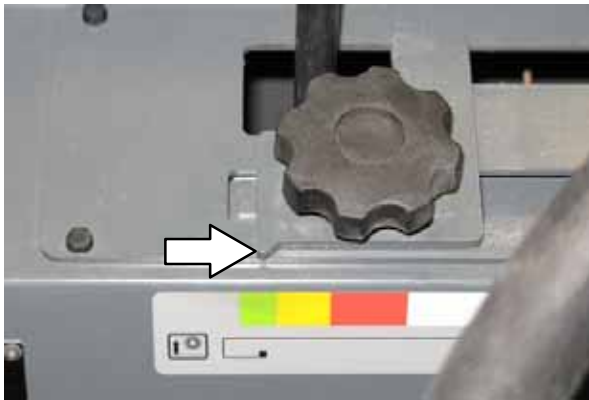

3. Recheck the pattern. Readjust if necessary.

SIDE BRUSH

Check the side brush daily for wear or damage. Remove any tangled string or wire from the side brush or side brush drive hub.

REPLACING THE SIDE BRUSH

Replace the brush(es) when it no longer cleans effectively.

1. Raise the side brush.

FOR SAFETY: Before leaving or servicing machine, stop on level surface, set parking brake, turn off machine, and remove key.

2. Remove the side brush retaining pin and then remove the side brush.



NOTE: Remove the drive hub and put it on the new brush if one is not installed.

3. Slide the new side brush onto the side brush drive shaft and reinstall the retaining pin.
4. Adjust the side brush pattern. Refer to *ADJUSTING THE SIDE BRUSH PATTERN*.

ADJUSTING THE SIDE BRUSH PATTERN

The side brush bristles should touch the floor between 10 o'clock and 4 o'clock when the brush is in motion.

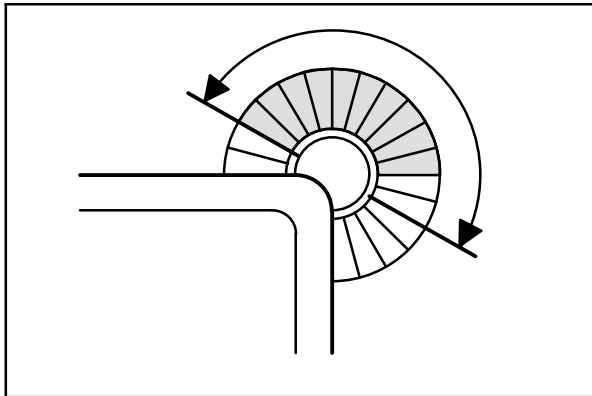

350327

S30: Turn the *side brush adjustment knob* counterclockwise to increase the brush pattern and clockwise to decrease the brush pattern.

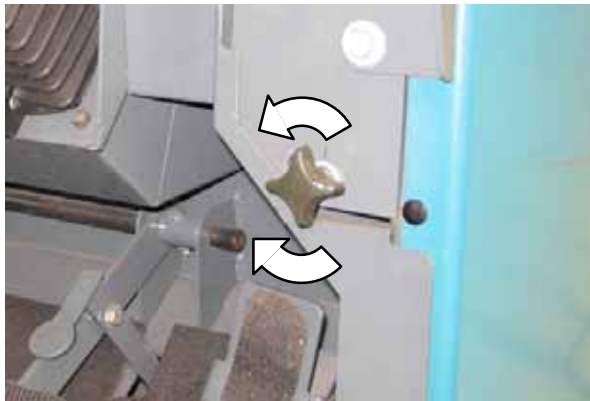

S30 XP and X4: Tighten the *side brush adjustment knob* into the side brush bracket to decrease the brush pattern and loosen the knob to increase the brush pattern.



ROTATING AND REPLACING THE SIDE BRUSH GUARD

Rotate the side brush guard 90° every 200 hours of operation. Replace the brush guard after all four sides have been used.



MAINTENANCE

SKIRTS AND FLAPS

FOR SAFETY: Before leaving or servicing machine, stop on level surface, set parking brake, turn off machine, and remove key.

HOPPER SKIRTS

Check the hopper skirts for wear or damage daily. Replace the hopper skirts when they no longer touch the floor.

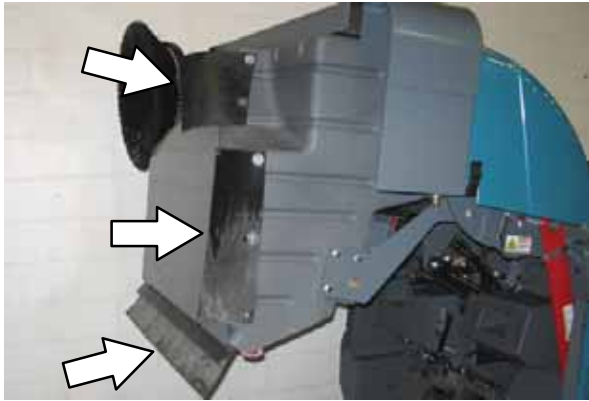

BRUSH DOOR SKIRTS

NOTE: Be sure the rear tire is properly inflated before checking skirt clearances.

The brush door skirts should clear the floor by 3 to 6 mm (0.12 to 0.25 in). Check the skirts for wear or damage and adjustment daily.



NOTE: The brush door skirts have slotted holes to allow for a ground clearance adjustment. The door must be closed for proper adjustment.

REAR SKIRTS

NOTE: Be sure the rear tire is properly inflated before checking skirt clearances.

The rear brush skirt should clear the floor by 3 to 6 mm (0.12 to 0.25 in). Check the skirt for wear or damage and adjustment daily.



SIDE BRUSH DUST CONTROL SKIRTS (OPTION)

The side brush dust control skirts wrap around the side brush and the front bumper.

Check the Side brush dust control skirts for wear or damage .



RECIRCULATION FLAP

The recirculation flap is self-adjusting. Check the flap for wear or damage daily.

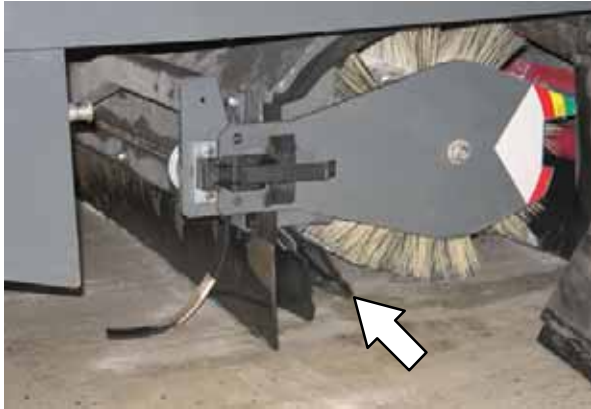

CYCLONIC CHAMBER AND DUST TRAY FLAPS (S/N 006501 -)

Check the cyclonic chamber and dust tray flaps for wear, damage, and debris buildup every 100 hours of operation or daily on machines equipped with HEPA. Inspect both flaps through the open hopper door. Both flaps should open and move freely.

If flaps do not open and move freely, remove dirt and debris preventing the flaps from opening. If necessary, use water to rinse dirt and debris from the flaps and the area around the flaps.

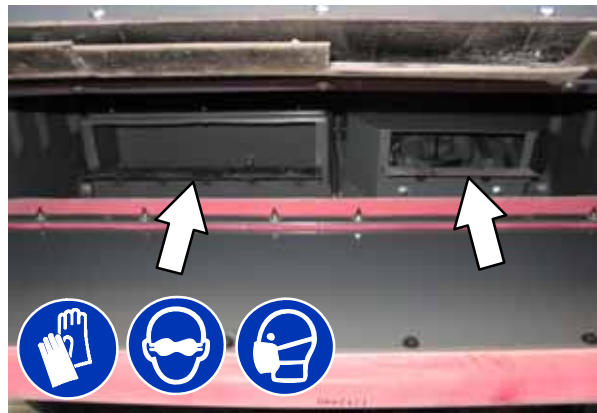

MAINTENANCE

SEALS

FOR SAFETY: Before leaving or servicing machine, stop on level surface, set parking brake, turn off machine, and remove key.

BRUSH DOOR SEALS

Check the brush door seals for wear or damage every 100 hours of operation.

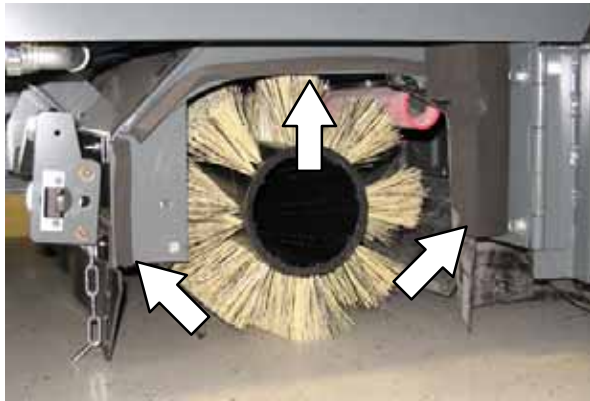

HOPPER SEALS

Check the hopper door seals for wear or damage every 100 hours of operation.

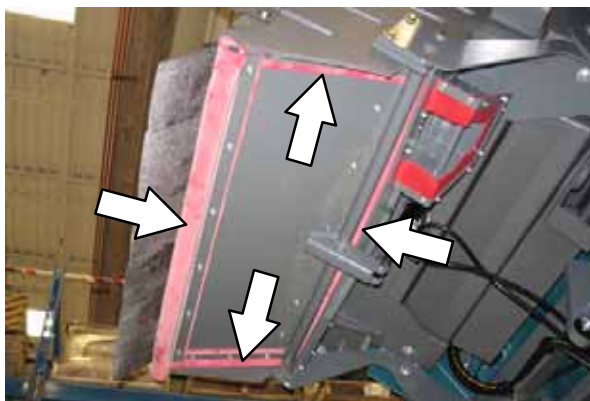
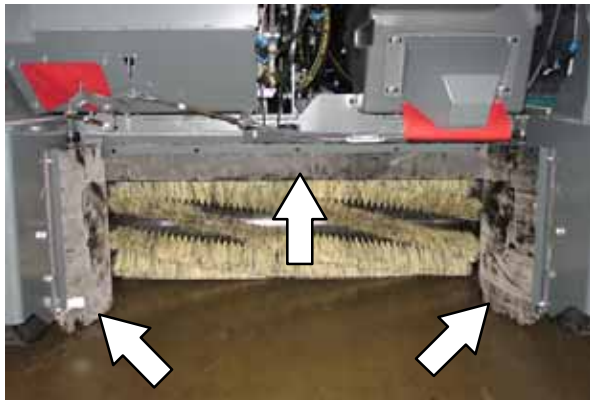

HOPPER ACCESS DOOR SEALS

Check the hopper access door seal for wear or damage every 100 hours of operation.



FILTER CHAMBER INLET SEAL

Check the filter chamber inlet seal for wear or damage every 100 hours of operation.

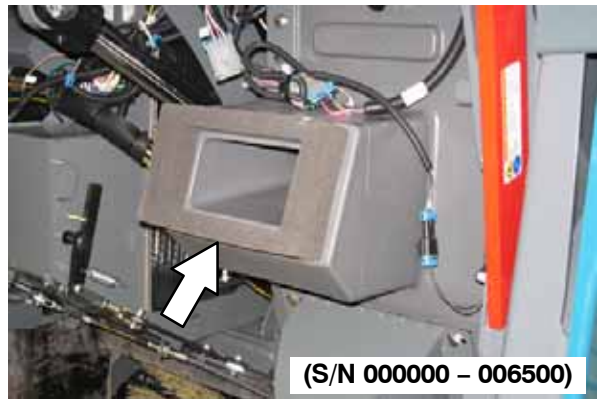

DUST RETURN SEALS (S/N 000000 – 006500)

Check the dust return seals for wear or damage every 100 hours of operation.

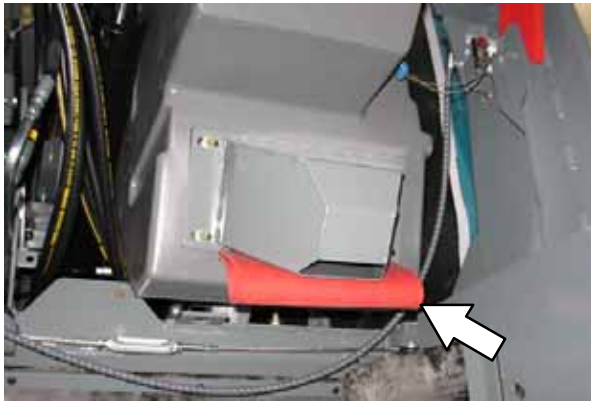

CYCLONE COVER SEALS (S/N 006501 –)

Check the cyclone cover seals for wear or damage every 100 hours of operation. Clean dust and debris from the cyclones as necessary.

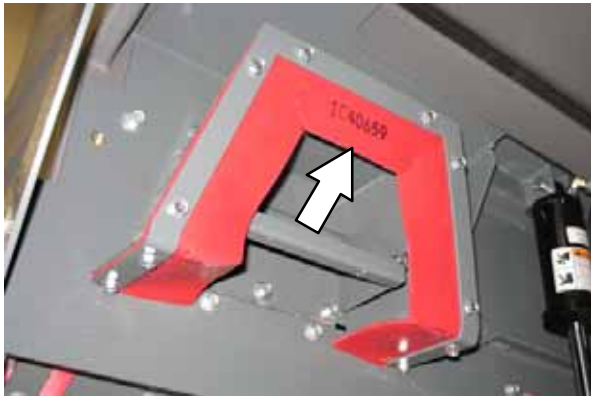
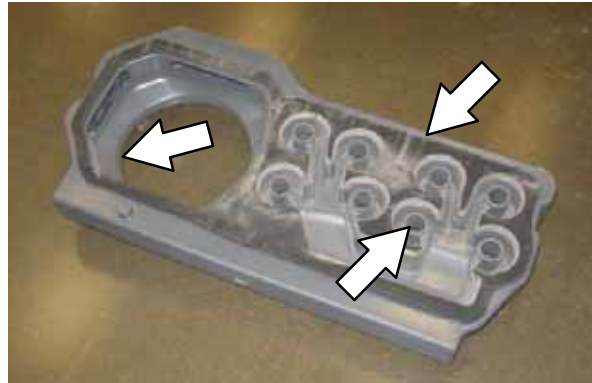

CYCLONE COVER ACCESS PORT SEAL (S/N 006501 –)

Check the cyclone cover access port seal for wear or damage every 100 hours of operation. Clean dust and debris from the seal as necessary.



DUST FILTER SEALS (S/N 000000 – 006500)

Check the dust filter seals for wear or damage every 100 hours of operation.

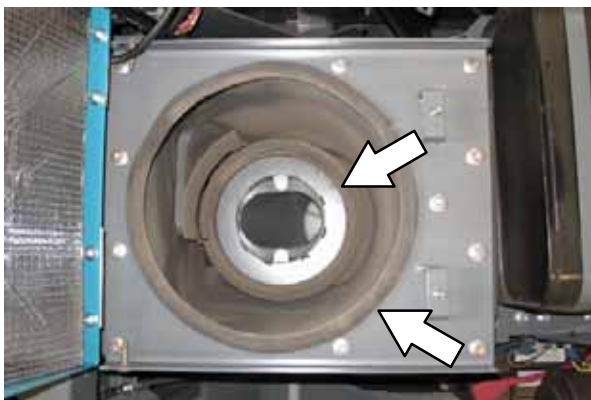

HOPPER DUST FILTER COVER SEAL (S/N 006501 –)

Check the hopper dust filter cover seal for wear or damage every 100 hours of operation or every 50 hours on machines equipped with HEPA. Clean dust and debris from the seal as necessary.



VACUUM WAND DOOR SEALS (OPTION)

Check the vacuum wand door seal for wear or damage every 100 hours of operation.

MAINTENANCE

BRAKES AND TIRES

BRAKES

Check the brake adjustment after every 200 hours of operation.

To check the brake adjustment, measure the distance from the stationary brake pedal to the point where there is resistance in the pedal movement. The distance must be 19 to 25 mm (0.75 to 1.0 in). Adjust the brakes if required.



TIRES

The standard front tires are solid. The standard rear tire is pneumatic.

Check the rear tire pressure every 100 hours of operation. The proper air pressure is 790 ± 35 kPa (115 ± 5 psi).

REAR WHEEL

Torque the rear wheel nuts twice in the pattern shown to 122 to 149 Nm (90 to 110 ft lb) after the first 50 hours of operation, and then after every 800 hours.

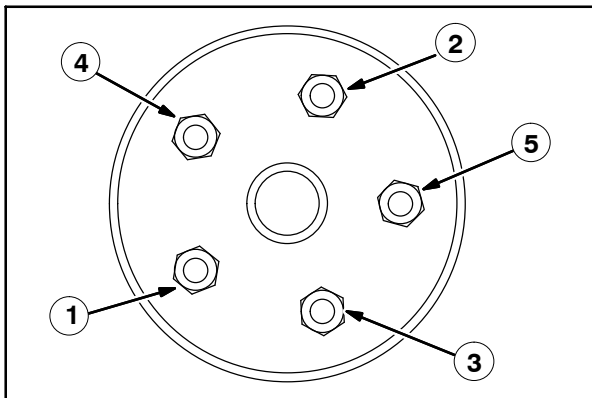

PROPELLING MOTOR

Torque the shaft nut to 508 Nm (375 ft lb) lubricated, 644 Nm (475 ft lb) dry, after every 800 hours of operation.



WET SIDE BRUSH DUST CONTROL (OPTION)

FILTER SCREEN

The wet side brush dust control filter screen is located under the water tank.

Remove and clean the wet side brush dust control filter screen after every 200 hours of operation.



SPRAY NOZZLES

The wet side brush dust control nozzles are located above the side brush (es). Check the spray pattern after every 50 hours.

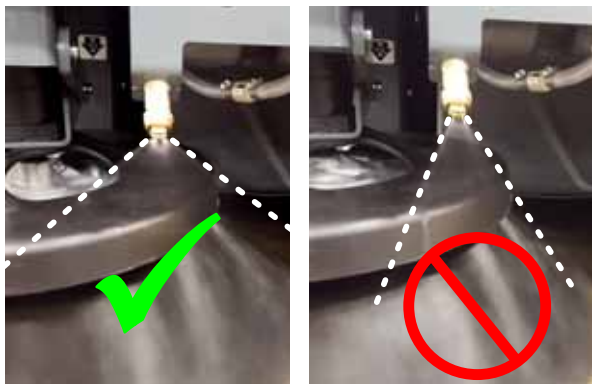

To adjust the spray pattern, use the water valve located under the water tank. Do not open the valve to the 90° maximum position. Optimal position is with the valve opened between 10–15°

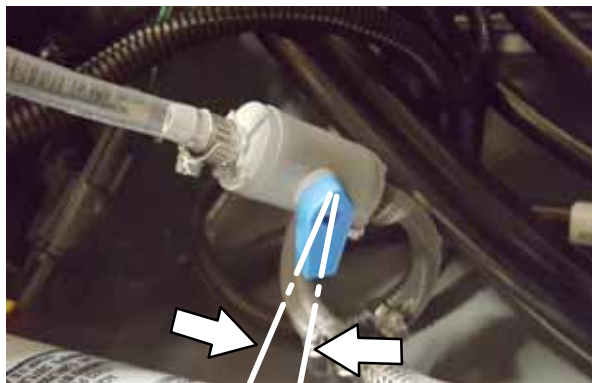

PUSHING, TOWING, AND TRANSPORTING THE MACHINE

PUSHING OR TOWING THE MACHINE

If the machine becomes disabled, it can be pushed from the front or rear, but only towed from the rear.

Use the *bypass valve* to prevent damaging the hydraulic system when pushing or towing the machine. This valve allows a disabled machine to be moved for a *very short distance* and at a speed to not exceed 1.6 kp/h (1 mph). The machine is NOT intended to be pushed or towed a long distance or at a high speed.

ATTENTION! Do not push or tow machine for a long distance or damage may occur to the propelling system.

Turn the *bypass valve* located on the bottom of the propelling pump 90° (either direction) from the normal position before pushing or towing the machine. Return the bypass valve to the normal position when finished pushing or towing the machine. **Do Not** use the bypass valve during normal machine operation.

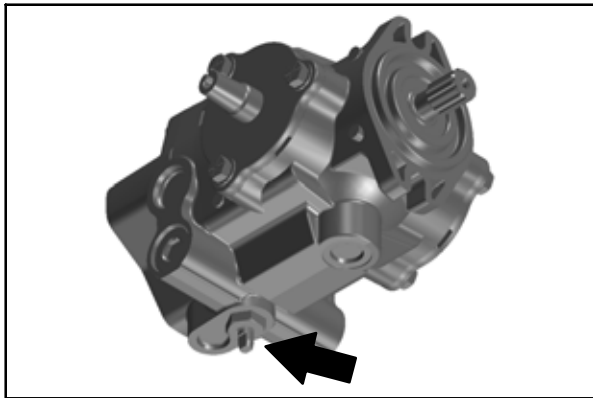

TRANSPORTING THE MACHINE

1. Raise the brushes. If necessary, slightly raise the hopper for additional ramp clearance.

FOR SAFETY: When loading machine onto truck or trailer, empty debris hopper before loading machine.

2. Position the front of the machine at the loading edge of the truck or trailer.

FOR SAFETY: When loading machine onto truck or trailer, use winch. Do not drive the machine onto the truck or trailer unless the loading surface is horizontal AND is 380 mm (15 in) or less from the ground.

3. If the loading surface is horizontal and 380 mm (15 in) or less from the ground, drive the machine onto the truck or trailer.



4. To winch the machine onto the truck or trailer, attach the winching chains to the holes in the right and left lower corners in front of the machine.



5. Position the machine as close to the front of the trailer or truck as possible.
6. Set the parking brake and place a block behind each wheel to prevent the machine from rolling.
7. Lower the brushes and hopper (if hopper was raised).
8. Connect the tie-down straps to the holes in the right and left lower corners in front of the machine and the holes in the rear jacking brackets behind the rear tires.



9. Route the tie-downs to the opposite ends of the machine and hook them to the brackets on the floor of the trailer or truck. Tighten the tie-down straps.

NOTE: It may be necessary to install tie-down brackets to the floor of the trailer or truck.



FOR SAFETY: When unloading machine off truck or trailer, use winch. Do not drive the machine off the truck or trailer unless the loading surface is horizontal AND 380 mm (15 in) or less from the ground.

10. If the loading surface is horizontal AND is 380 mm (15 in) or less from the ground, drive the machine off the truck or trailer.

MAINTENANCE

MACHINE JACKING

Empty the hopper before jacking up the machine. Jack up the machine at the designated locations. Use a hoist or jack capable of supporting the weight of the machine. Use jack stands to support the machine.

FOR SAFETY: Before leaving or servicing machine, stop on level surface, set parking brake, turn off machine, and remove key.

FOR SAFETY: When servicing machine, block machine tires before jacking machine up. Use a hoist or jack that will support the weight of the machine. Jack machine up at designated locations only. Support machine with jack stands.

Rear jacking locations are located directly behind the rear tire on each side of the machine.



Front jacking locations are located on the frame directly in front of the front tire.



STORAGE INFORMATION

The following steps should be taken prior to storing the machine for extended periods.

1. Park the machine in a cool, dry area. Do not expose the machine to rain or snow. Store indoors.
2. Remove the battery, or charge battery every three months.

FREEZE PROTECTION FOR WET SIDE BRUSH DUST CONTROL SYSTEM

1. Drain the water tank with the drain valve located under the tank.
2. Drain the water lines and pump by pressing on the wet side brush dust control switch to the on position. Press the switch to the off position when the wet side brush dust control light turns red.
3. Remove the wet side brush dust control filter screen, located under the tank, and empty it.

SPECIFICATIONS

GENERAL MACHINE DIMENSIONS/CAPACITIES

Item	Dimension/capacity
Length	2360 mm (93 in)
Height	1475 mm (58 in)
Height (with overhead guard)	2095 mm (82.5 in)
Width/frame	1590 mm (62.5 in)
Wheel base	1226 mm (48.25 in)
Track	1426 mm (56.125 in)
Cleaning path width (Single side brush)	1590 mm (62.5 in)
Cleaning path width (Dual side brushes)	2030 mm (80 in)
Main brush diameter	356 mm (14 in)
Side brush diameter	660 mm (26 in)
Debris hopper volume capacity (Plastic and Steel)	395 L (14 ft ³)
Debris hopper weight capacity (Plastic)	490 kg (1080 lbs)
Debris hopper weight capacity (Steel)	545 kg (1200 lbs)
Wet side brush dust control water tank (option)	41.6 L (11 gal)
Dump height (variable to)	1525 mm (60 in)
Minimum ceiling dump height	2500 mm (98 in)
Weight – empty	1595 Kg (3520 lbs)
GVWR	2630 Kg (5800 lbs)
Transport ground clearance	100 mm (4 in)
Protection Grade	IPX3

Values determined as per IEC 60335-2-72	Measure
Sound pressure level L_{pA}	80 dB(A)
Sound pressure uncertainty K_{pA}	3 dB(A)
Sound power level L_{WA} + Uncertainty K_{WA}	102 dB(A)
Vibration – Hand–arm	< 2.5 m/s ²
Vibration – Whole body	< 0.5 m/s ²

GENERAL MACHINE PERFORMANCE

Item	Measure
Minimum aisle turn	2870 mm (113 in)
Travel speed forward (maximum)	13.0 Km/h (8 mph)
Travel speed reverse (maximum)	5.0 Km/h (3 mph)
Maximum ramp incline for loading – Empty	25%
Maximum ramp incline for sweeping	14%
Maximum ramp incline for transporting (GVWR)	17%

SPECIFICATIONS

POWER TYPE

Engine	Type	Ignition	Cycle	Aspiration	Cylinders	Bore	Stroke
GM 1.6 (S/N 000000 – 005699)	Piston	Distributorless-type spark	4	Natural	4	79 mm (3.11 in)	81.5 mm (3.21 in)
	Displacement		Tennant governed power			Gross intermittent power per SAE J1995	
	1600 cc (98 cu in)		23.2 kw (32 hp) @ 2400 rpm			41 kw (55 hp) @ 4000 rpm	
	Fuel		Cooling system			Electrical system	
	Gasoline, 87 octane minimum, unleaded Fuel tank: 42 L (11.2 gal)		Water/ethylene glycol antifreeze			12 V nominal	
	LPG, Fuel tank: 15 kg (33 lb)		Total: 7.5 L (2 gal) Radiator: 3.8 L (1 gal)			75 A alternator	
	Idle speed, no load		(Fast) governed speed, under load			Firing order	
	1350 ± 50 rpm		Normal sweep mode: 2000 ± 50 rpm Litter sweep mode: 2400 ± 50 rpm			1-3-4-2	
	Spark plug gap		Valve clearance, cold			Engine lubricating oil with filter	
	1 mm (0.035 in)		No Adjustment OHC Engine			3.5 L (3.7 qt) 5W30 SAE-SG/SH	

Engine	Type	Ignition	Cycle	Aspiration	Cylinders	Bore	Stroke
Mitsubishi 2.0 (S/N 005700 –)	Piston	Coil @ Plug	4	Natural	4	85 mm (3.35 in)	88 mm (3.46 in)
	Displacement		Tennant governed power			Gross intermittent power per SAE J1995	
	1997 cc (122 cu in)		LPG – 31.6 kW (42.4 Hp) @ 2300 rpm			LPG – 38.5 kW (51.6 Hp) @ 2800 rpm	
			Gasoline – 30.3 kW (40.6 Hp) @ 2300 rpm			Gasoline – 37.8 kW (50.7 Hp) @ 2800 rpm	
	Fuel		Cooling system			Electrical system	
	Gasoline, 87 octane minimum, unleaded Fuel tank: 42 L (11.2 gal)		Water/ethylene glycol antifreeze			12 V nominal	
	LPG, Fuel tank: 15 kg (33 lb)		Total: 7.5 L (2 gal) Radiator: 3.8 L (1 gal)			75 A alternator	
	Idle speed, no load		(Fast) governed speed, under load			Firing order	
	1350 ± 50 rpm		2300 ± 50 rpm			1-3-4-2	
	Spark plug gap		Valve clearance, cold			Engine lubricating oil with filter	
1.1 mm (0.043 in)		No Adjustment OHC Engine			4.7 L (5 qt) 5W30 SAE-SG/SH		

HYDRAULIC SYSTEM

System	Capacity	ISO Grade Viscosity Index	Ambient Air Temperature Ranges
Hydraulic reservoir	38 L (10 gal)	ISO 100 VI 126 or higher	19° C (65° F) or higher
Hydraulic total	45 L (12 gal)	ISO 68 VI 155 or higher	7 to 43° C (45 to 110° F)
		ISO 32 VI 163 or higher	16° C (60° F) or lower

STEERING

Type	Power source
Rear wheel, hydraulic cylinder	Hydraulic accessory pump

BRAKING SYSTEM

Type	Operation
Service brakes	Mechanical drum brakes (2), one per front wheel, cable actuated
Parking brake	Utilize service brakes, cable actuated

TIRES

Location	Type	Size
Front (2)	Solid	127 mm x 535 mm (5 in x 21 in)
Rear (1)	Pneumatic	115 mm x 470 mm (4.5 in x 18.5 in)

MACHINE DIMENSIONS

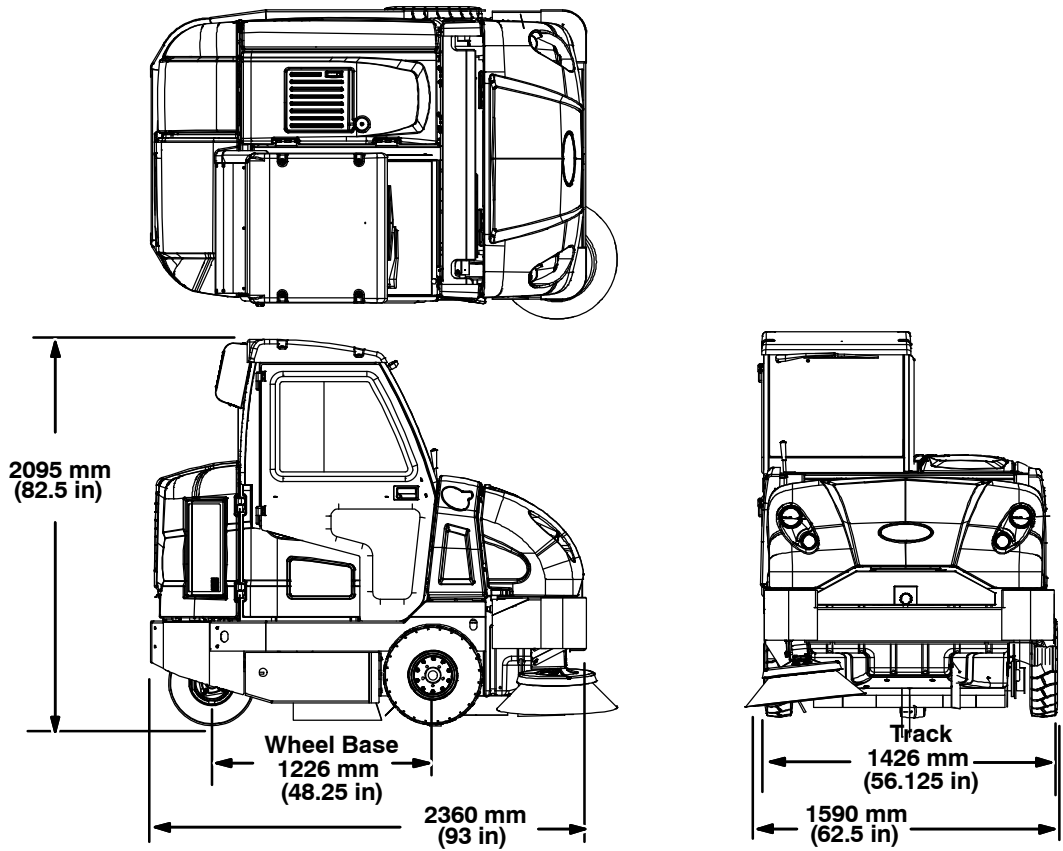
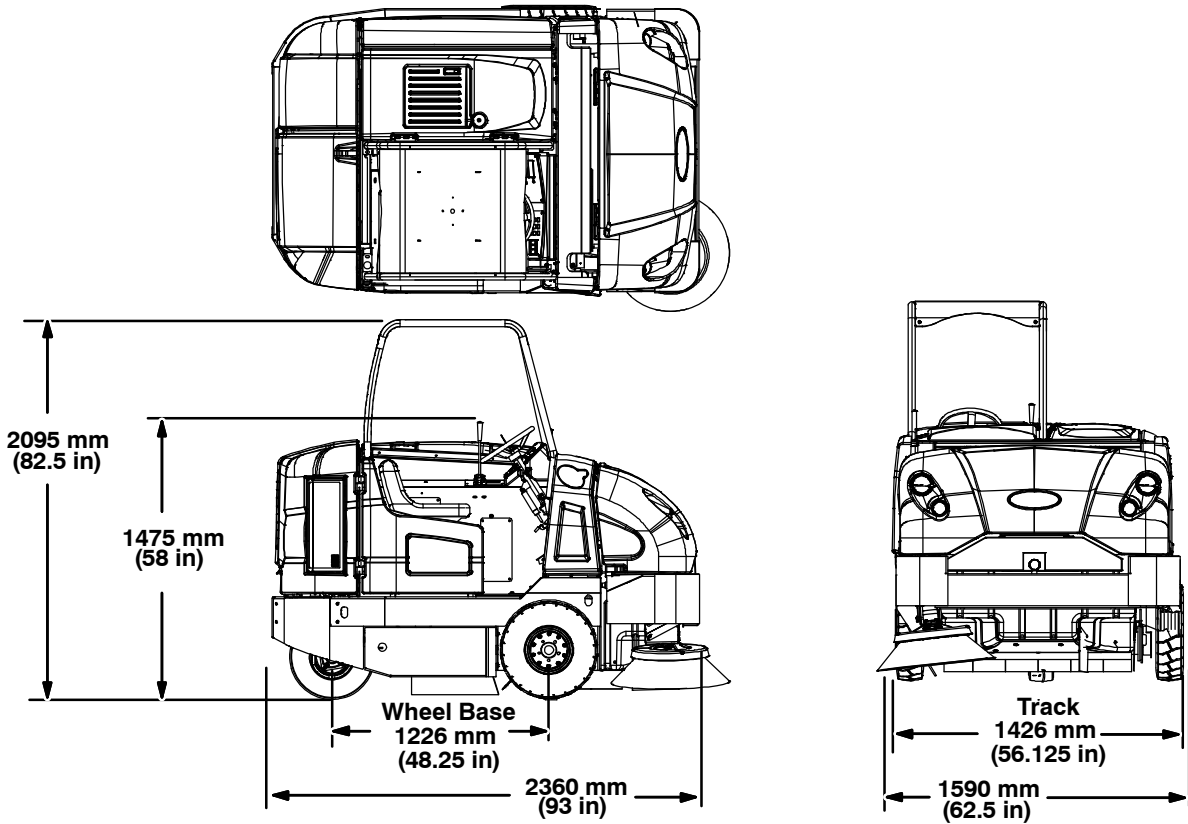

354726

1

1–STEP Sweep button, 14, 25

A

Access door, hopper, 16

Adjust deluxe suspension seat, 17

Adjust operator seat, 17

Adjust steering column, 11

Adjusting the Main Brush Taper, 67

Adjusting the Main Brush Width, 68

Adjusting the Side Brush Pattern, 69

Air Filter, 48

 Replace the safety filter element, 48

Air filter indicator, 48

 Reset, 49

Alarms, 29, 30

 Fault Indicators (S30 XP and X4), 30

 Fault Indicators (S30), 29

B

Battery, 51

Belts, Camshaft and Balance, 51

Blower Wand (Option), 32

Brake pedal, 11

Brakes, 74

 System specifications, 81

Brakes and Tires, 74

 Brakes, 74

 Rear Wheel, 74

 Tires, 74

Brush Door Seals, 72

Brush Door Skirts, 70

Brush Information, 18

Buttons

 1–STEP Sweep button, 14, 25

 Contrast control button, 14

 Engine Speed Button, 13

 Filter shaker button, 15

 Hopper door close button, 26

 Hopper lower button, 27

 Hopper raise button, 26

 Supervisor Control Buttons, 13

 Vacuum fan button, 14, 32

Buttons, Controls and Instruments, 9, 13

Bypass valve, 76

C

Cab Fuses, 53

Cab light (Option), 33

Cab light switch, 33

Camshaft and Balance Shaft Belts, 51

Capacities, 79

Changing the LPG Tank, 21

Checking the Main Brush Pattern, 67

Clean Hepa Filter Housing, 63

Clean the hopper, 54

Cleaning the Cyclone Assembly, 59

Cleaning the Dust Filter, 58

Cleaning the lower cyclone chamber, 60

Cleaning the lower cyclone chamber (HEPA Option), 60

Cleaning the upper cyclone chamber, 59

Contrast control button, 14

Controls and Instruments, 8, 9

 Touch Panel, 9

Cooling System, 46

 Check the coolant level in the reservoir, 46

 Flush the radiator and the cooling system, 46

Cyclone Assembly

 Cleaning, 59

 Cleaning the lower cyclone chamber, 60

 Cleaning the lower cyclone chamber (HEPA Option), 60

 Cleaning the upper cyclone chamber, 59

Cyclone cover access port seal, 73

Cyclone cover seals, 73

Cyclone Perma–Filter, 62

Cyclonic Dust Tray Flaps, 71

D

Dash fault indicators, 31

Dimensions, 79

Directional pedal, 11

Disengaging hopper support bar, 28

Dust Filter, 55, 56

 Check Dust Filter Seal Height, 57

 Removing the Dust Filter, 55, 56

 Replacing the Dust Filter, 55, 56

Dust Filter Seals, 73

Dust Return Seals, 73

E

Electronic Pressure Regulator, 50
Emptying the hopper, 26
Engaging hopper support bar, 27
Engine, 46
 Air Filter, 48
 Air filter indicator, 48
 Camshaft and Balance Shaft Belts, 51
 Clean the engine and engine compartment, 47
 Cooling System, 46
 Electronic Pressure Regulator, 50
 Engine Belt, 51
 Fuel Filter, 49
 LPG Vaporizer, 50
 PCV System, 51
 Spark Plugs, 50
 Specifications, 80
 Timing Belt, 51
Engine air filter, Cleaning, 48 – 50
Engine Belt, 51
Engine Harness Fuses and Relays, 53
Engine Oil, 43
Engine Speed Button, 13
Engine Speed Switch, 13

F

Fan knob, 33
Fault Indicators (S30 XP and X4), 30
Fault Indicators (S30), 29
Filter Chamber Inlet Seal, 72
Filter screen, 75
Filter shaker button, 15
Filter shaker switch, 15
Filters, 55, 56
 Check Dust Filter Seal Height, 57
 Cleaning the Dust Filter, 58
 Cyclone Perma-Filter, 62
 Engine Air Filter, 48
 Gasoline Fuel Filter, 49
 Hepa, 63
 Hydraulic Fluid Filter, 44
 LPG Fuel Filter, 49
 Removing the Dust Filter, 55, 56
 Replacing the Dust Filter, 55, 56
Flaps, 70
Freeze protection, Wet dust control, 78
Front jacking locations, 78
Front Wheel Bearings, 43

Fuel Filter
 Gasoline, 49
 LPG, 49
Fuel Indicator, 12
Fuses and Relays, 52
 Cab Fuses, 53
 Engine Harness Fuses and Relays, 53
 Relay Panel Fuses and Relays, 52

G

General Machine Dimensions / Capacities, 79
General Machine Performance, 79

H

Headlights, 15
Heater / Air conditioner (Option), 33
Heater / Air conditioner switch, 33
HEPA, Troubleshooting, 37
HEPA Filter, 54
Hopper, Clean, 54
Hopper access door, 16
Hopper door switch, 24, 26
Hopper dust filter cover seal, 73
Hopper Inspection Door Seals, 72
Hopper Lift Arm Bearings, 43
Hopper lower button, 27
Hopper lower switch, 27
Hopper raise button, 26
Hopper raise switch, 26
Hopper Seals, 72
Hopper Skirt, 70
Hopper support bar, 27
 Disengaging hopper support bar, 28
 Engaging hopper support bar, 27
Hour Meter, 13
How the Machine Works, 19
Hydraulic Cooler, 47
 Clean the fins, 47
Hydraulic Fluid, 45
Hydraulic Hoses, 45
Hydraulic System, System specifications, 81
Hydraulics, 44
 Check the hydraulic fluid level, 44
 Check the hydraulic hoses, 45
 Hydraulic Fluid, 45

Hydraulic Hoses, 45
 Replace the hydraulic fluid filter, 44

I

Indicators

Dash fault indicators, 31
 Fault Indicators (S30 XP and X4), 30
 Fault Indicators (S30), 29
 Fuel Indicator, 12
 Hour Meter, 13

K

Knobs

Fan knob, 33
 Side Brush Adjustment Knob, 69
 Temperature knob, 33

L

Lights

Operating / hazard, 15
 Operating / hazard light, 15

LPG Vaporizer, 50

Lubrication, 43

Engine Oil, 43
 Front Wheel Bearings, 43
 Hopper Lift Arm Bearings, 43
 Rear Wheel Support Bearing, 43
 Steering Cylinder Bearing, 43

M

Machine components, 7

Machine Dimensions, 82

Machine Jacking, 78

Front jacking locations, 78
 Rear jacking locations, 78

Machine Operation, Pre—Operation Checklist, 20

Machine Performance

Aisle Turnaround Width, 79
 Climb and Descent Angles, 79
 Travel Speed (Maximum), 79

Machine Specifications, 79 – 82

Machine Troubleshooting, 36

HEPA, 37

Main Brushes, 65

Adjusting the Taper, 67
 Adjusting the Width, 68
 Checking the Main Brush Pattern, 67
 Replacing or Rotating the Main Brushes, 65

Main Brushes, Adjusting the Taper, 67

Main Brushes, Adjusting the Width, 68

Main Brushes, Checking the Pattern, 67

Main Brushes, Replacing or Rotating, 65

Maintenance, 38 – 62

Maintenance Chart, 38

O

Operating / hazard lights, 15

Operating temperature, 23

Operation, 7 – 31

Operation of controls, 11

Operator seat, 17

Option, HEPA Filter, 54

Options, 32

Blower wand, 32

Cab light, 33

Heater / Air conditioner, 33

Side brush light, 15

Tower bumpers, 35

Turn Signal, 35

Vacuum wand, 32

Wet side brush dust control system, Operation,
 34 – 36

Windshield wiper, 33

P

Parking brake pedal, 11

PCV System, 51

Pedals

Brake pedal, 11

Directional pedal, 11

Parking brake pedal, 11

Steering column tilt pedal, 11

Pre—Operation Checklist, 20

Propelling Motor, 74

Torque Shaft Nut, 74

Pushing or Towing the Machine, 76

Pushing the Machine, 76

Pushing, Towing, and Transporting the Machine,
 76

Pushing or Towing the Machine, 76

Transporting the Machine, 76

R

Radiator, 47
 Check hoses and clamps, 47
 Clean core exterior, 47
Rear jacking locations, 78
Rear Skirt, 70
Rear Wheel Support Bearing, 43
Rear Wheel, Torque, 74
Recirculation Flap, 71
Relay Panel Fuses and Relays, 52
Removing the Dust Filter, 55, 56
Replacing or Rotating the Main Brushes, 65
Replacing the Dust Filter, 55, 56
Replacing the Side Brush, 68
Replacing the Side Brush Guard, 69
Reset air filter indicator, 49
Rotating the Side Brush Guard, 69

S

Safety
 Instructions, 3 – 5
 Labels, 5 – 7
Seals, 72
 Brush Door Seals, 72
 Cyclone cover access port seal, 73
 Cyclone cover seals, 73
 Dust Filter Seals, 73
 Dust Return Seals, 73
 Filter Chamber Inlet Seal, 72
 Hopper dust filter cover seal, 73
 Hopper Inspection Door Seals, 72
 Hopper Seals, 72
 Vacuum Wand Door Seals, 73
Seat belts, 17
Seat, deluxe suspension, 17
Seat, Operator, 17
Setting the Engine Speed, 13
Side Brush, 68
 Adjusting the Side Brush Pattern, 69
 Replacing the Side Brush, 68
 Replacing the Side Brush Guard, 69
 Rotating the Side Brush Guard, 69
Side Brush Adjustment Knob, 69
Side brush dust control, Wet, Operation, 34 – 36
Side Brush Dust Control Skirts (Option), 70
Side Brush Guard, Replacing, 69

Side Brush Guard, Rotating, 69
Side brush light switch (option), 15
Side Brush, Adjusting the Pattern, 69
Side Brush, Replacing, 68
Skirts, 70
Skirts and Flaps, 70
 Brush Door Skirts, 70
 Cyclonic Dust Tray Flap, 71
 Hopper Skirts, 70
 Rear Skirt, 70
 Recirculation Flap, 71
 Side Brush Dust Control Skirts (Option), 70
Spark Plugs, 50
Specifications, 79 – 82
 Braking system, 81
 General Machine Dimensions / Capacities, 79 – 82
 General Machine Performance, 79 – 82
 Hydraulic System, 81 – 84
 Machine Capacities, 79
 Machine Dimensions, 79
 Machine Performance, 79
 Power Type, 80
 Steering, 81
 Tires, 81
Spray nozzles, 75
Starting the machine, 22
Steering, Specifications, 81
Steering Cylinder Bearing, 43
Storage Information, 78
 Storing the Machine, 78
Storing machine, Freeze protection, 78
Supervisor Control Buttons, 13
Sweeping (S30 XP and X4), 25
Sweeping (S30), 24
Switches
 Cab light switch, 33
 Engine Speed Switch, 13
 Filter shaker switch, 15
 Heater / Air conditioner switch, 33
 Hopper door switch, 24, 26
 Hopper lower switch, 27
 Hopper raise switch, 26
 Operating / hazard light switch, 15
 Side brush light switch, 15
 Turn signal switch, 35
 Vacuum fan, 14, 24
 Wand switch, 32
 Wet side brush dust control switch, 34
 Windshield wiper switch, 33
Symbol definitions, 10 – 12

T

Temperature, Operating, 23
Temperature knob, 33
Timing Belt, 51
Tires, 74
 Specifications, 81
Touch Panel, 9
Tower bumpers (Option), 35
Towing the Machine, 76
Transporting the Machine, 76
Turn Signal (Option), 35
Turn signal switch, 35
Turning off the machine, 22

V

Vacuum fan button, 14, 32
Vacuum fan switch, 14, 24
Vacuum Wand (Option), 32
Vacuum Wand Door Seals, 73
Vaporizer, 50

W

Wand (Option), 32
Wand switch, 32
Warning Indicators, 30
 Dash fault indicators, 31
 Fault Indicators (S30 XP and X4), 30
 Fault Indicators (S30), 29
Warning Indicators (S30), 29
Wet side brush dust control, 75
Wet side brush dust control (Option)
 Filter screen, 75
 Spray nozzles, 75
Wet side brush dust control switch, 34
Wet side brush dust control system, Operation,
 34 – 36
Wheels, 74
While operating the machine, 23
Windshield wiper (Option), 33
Windshield wiper switch, 33

