

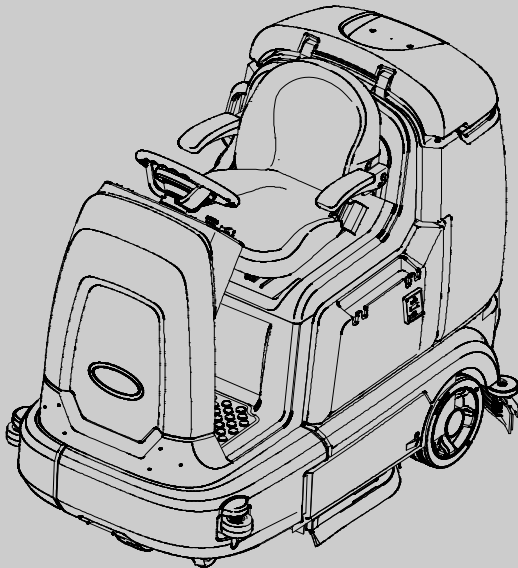

T12

(Battery)

Rider Scrubber Operator Manual



*The Safe Scrubbing Alternative[®]
Tennant True[®] Parts
IRIS[®] a Tennant Technology
Insta-Fit[™] Adapter*



North America / International



For the latest parts manuals and other language Operator manuals, visit:

www.tennantco.com/manuals

9009910
Rev. 09 (2-2022)



INTRODUCTION

This manual is furnished with each new model. It provides necessary operation and maintenance instructions.



Read this manual completely and understand the machine before operating or servicing it.

This machine will provide excellent service. However, the best results will be obtained at minimum costs if:

- The machine is operated with reasonable care.
- The machine is maintained regularly - per the machine maintenance instructions provided.
- The machine is maintained with manufacturer supplied or equivalent parts.

PROTECT THE ENVIRONMENT



Please dispose of packaging materials, used components such as batteries and fluids in an environmentally safe way according to local waste disposal regulations.



Always remember to recycle.

MACHINE DATA

Please fill out at time of installation for future reference.

Model No. – _____

Serial No. – _____

Installation Date – _____

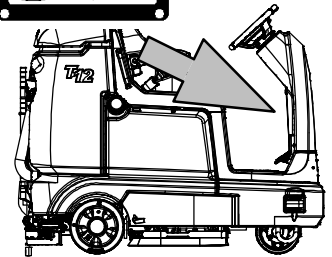

INTENDED USE

The T12 is an industrial/commercial rider machine designed to wet scrub both rough and smooth hard surfaces (concrete, tile, stone, synthetic, etc). Typical applications include schools, hospitals / health care facilities, office buildings, and retail centers. Do not use this machine on soil, grass, artificial turf, or carpeted surfaces. This machine is intended for indoor use only. This machine is not intended for use on public roadways. Do not use this machine other than described in this Operator Manual.

Tennant Company

10400 Clean Street
Eden Prairie, MN 55344-2650
Phone: (800) 553-8033

Touch-N-Go, 1-STEP, Grip-N-Go, Dura-Track, SmartRelease, Duramer, Insta-Fit are trademarks of Tennant Company.

Flow-Rite is a registered trademark of Flow-Rite Controls.

Hydrolink is a registered trademark of Trojan® Battery Company.

Specifications and parts are subject to change without notice.

Original Instructions, copyright © 2013 – 2019, 2022 TENNANT Company, Printed in U.S.A.

CONTENTS

	Page		Page
Important Safety Instructions – Save These Instructions	3	Maintenance	40
Operation	8	Maintenance Chart	40
Machine Components	8	Yellow Touch Points	42
Controls And Instruments (T12)	9	Lubrication	42
Touch Panel (T12)	10	Steering Chain (T12xp Only)	42
Controls And Instruments (T12xp)	11	Steering Gear Chain	42
Touch Panel (T12xp)	12	Rear Squeegee Casters	42
Symbol Definitions	13	Batteries	43
Installing Batteries	14	Flooded (Wet) And Maintenance-Free Sealed Lead-Acid Batteries	43
Flooded/Sealed Lead-Acid Batteries ..	14	Checking The Electrolyte Level	43
Battery Specifications	14	Maintenance-Free Batteries	43
Lithium-Ion Battery	15	Checking Connections / Cleaning	43
Operation Of Controls	15	Lithium-Ion Battery Pack	44
Battery Discharge Indicator	15	Charging The Batteries (Off-Board Charger)	44
Hour Meter	15	Charging The Batteries (On-Board Charger)	45
Recovery Tank Full Indicator	15	On-Board Battery Charger Error Codes	46
Emergency Shut-Off Button	16	On-Board Charger Settings	47
Operating / Hazard Light Switch (Option)	16	Changing The On-Board Battery Charger Fuse	49
Operator Seat	17	Flow-Rite™ Battery Watering System (Option)	50
Seat Belts (Deluxe Seat Option Only) ..	17	Hydrolink® Battery Watering System (Option)	52
Seat Support	17	Manual Battery Watering System (Trojan® Battery Option)	54
Contrast Control Button	18	Circuit Breakers	56
Configuration Mode Button	18	Electric Motors	57
Propel Pedal	18	Scrub Brushes	58
Directional Switch	18	Disk Brushes And Pads	58
Brake Pedal	18	Replacing Disk Brushes Or Pad Drivers	58
Vacuum Fan / Squeegee Button	19	Replacing Disk Scrub Pads	59
Solution On / Off Button	19	Cylindrical Brushes	60
How The Machine Works	19	Replacing Cylindrical Scrub Brushes ..	60
Brush And Pad Information	20	Side Brush (Option)	61
While Operating The Machine	21	Replacing The Side Brush	61
Pre-Operation Checklist	21	Squeegee Blades	62
Starting The Machine	22	Replacing (Or Rotating) The Rear Squeegee Blades	62
Filling The Solution Tank	22	Leveling The Rear Squeegee	65
Ec-H2o Scrubbing (Ec-H2o Mode) ..	22	Adjusting The Rear Squeegee Blade Deflection	66
Conventional Scrubbing Mode	23	Replacing Or Rotating The Side Squeegee Blades	67
Ec-H2o Button (Option)	23	Replacing Or Rotating The Side Brush Squeegee Blades (Option)	68
Setting Brush Pressure	24	Skirts And Seals	70
Setting Solution Flow	24	Recovery Tank Seal	70
Scrubbing	25	Scrub Head Skirts (Disk Scrub Heads Only)	70
Double Scrubbing	26	Belts	70
Water Pickup Mode (No Scrubbing)	27	Cylindrical Brush Drive Belts	70
Stop Scrubbing	27	Tires	70
Draining And Cleaning The Recovery Tank	28		
Draining And Cleaning The Solution Tank ..	30		
Turn Off The Machine	31		
Fault Indicator(S)	32		
Warning Codes	33		
Options	34		
Spray Nozzle (Option)	34		
Vacuum Wand (Option)	35		
Rear Squeegee Guard (Option)	36		
Side Brush (Option)	37		
Adjusting Backup Alarm Volume (Option)	37		
Machine Troubleshooting	38		

CONTENTS

	Page
Pushing, Towing, And Transporting	
The Machine	71
Pushing Or Towing The Machine	71
Transporting The Machine	71
Machine Jacking	73
Ec-H2o Module Flush Procedure	74
Storage Information	76
Freeze Protection	76
Preparing The Machine For Operation	
After Storage	78
Priming The Ec-H2o System	80
Specifications	82
General Machine Dimensions/Capacities .	82
General Machine Performance	83
Power Type	83
Tires	83
Standard Solution Flow Rate	83
Side Brush Solution Flow Rate (Option) ..	84
Ec-H2o System (Option)	84
Machine Dimensions	84

IMPORTANT SAFETY INSTRUCTIONS – SAVE THESE INSTRUCTIONS

The following precautions are used throughout this manual as indicated in their description:

 **WARNING: To warn of hazards or unsafe practices that could result in severe personal injury or death.**

FOR SAFETY: To identify actions that must be followed for safe operation of equipment.

The following information signals potentially dangerous conditions to the operator. Know when these conditions can exist. Locate all safety devices on the machine. Report machine damage or faulty operation immediately.

 **WARNING: Lead-acid batteries emit hydrogen gas. Explosion or fire can result. Keep sparks and open flame away. Keep covers open when charging.**

 **WARNING: Flammable materials can cause an explosion or fire. Do not use flammable materials in tank(s).**

 **WARNING: Flammable materials or reactive metals can cause an explosion or fire. Do not pick up.**

 **WARNING: Electrical Hazard**

- Disconnect Battery Cables and Charger Plug Before Servicing Machine.
- Do Not Charge Batteries with Damaged Power Supply Cord. Do Not Modify Plug.

If the charger supply cord is damaged or broken, it must be replaced by the manufacturer or its service agent or a similarly qualified person in order to avoid a hazard.

This machine may be equipped with technology that automatically communicates over the cellular network. If this machine will be operated where cell phone use is restricted because of concerns related to equipment interference, please contact a Tennant representative for information on how to disable the cellular communication functionality.

FOR SAFETY:

1. Do not operate machine:
 - Unless trained and authorized.
 - Unless operator manual is read and understood.
 - Under the influence of alcohol or drugs.
 - While using a cell phone or other types of electronic devices.
 - Unless mentally and physically capable of following machine instructions.
 - With brake disabled.
 - If it is not in proper operating condition.
 - With pads or accessories not supplied or approved by Tennant. The use of other pads may impair safety.
 - In outdoor areas. This machine is for indoor use only.
 - In areas where flammable vapors/liquids or combustible dusts are present.
 - In areas that are too dark to safely see the controls or operate the machine unless operating / headlights are turned on.
 - In areas with possible falling objects unless equipped with overhead guard.
2. Before starting machine:
 - Check machine for fluid leaks.
 - Make sure all safety devices are in place and operate properly.
 - Check brakes and steering for proper operation.
 - Adjust seat and fasten seat belt (if equipped).

SAFETY PRECAUTIONS

3. When using machine:

- Use only as described in this manual.
- Use brakes to stop machine.
- Go slowly on inclines and slippery surfaces.
- Do not scrub on ramp inclines that exceed 7% (4°) grade or transport (GVWR) on ramp inclines that exceed 14% (8°) grade.
- Reduce speed when turning.
- Keep all parts of body inside operator station while machine is moving.
- Always be aware of surroundings while operating machine.
- Use care when reversing machine.
- Keep children and unauthorized persons away from machine.
- Do not carry passengers on any part of the machine.
- Always follow safety and traffic rules.
- Report machine damage or faulty operation immediately.
- Follow mixing, handling and disposal instructions on chemical containers.
- Follow site safety guidelines concerning backup alarms.
- Follow site safety guidelines concerning wet floors.

4. Before leaving or servicing machine:

- Stop on level surface.
- Turn off machine and remove key.

5. When servicing machine:

- All work must be done with sufficient lighting and visibility.
- Keep work area well ventilated.
- Avoid moving parts. Do not wear loose clothing, jewelry and secure long hair.
- Block machine tires before jacking machine up.
- Jack machine up at designated locations only. Support machine with jack stands.
- Use hoist or jack that will support the weight of the machine.
- Do not push or tow the machine without an operator in the seat controlling the machine.
- Do not power spray or hose off machine near electrical components.
- Disconnect battery connections and charger cord before working on machine.
- Do not pull on battery charger cord to unplug. Grasp plug at outlet and pull.
- Do not use incompatible battery chargers as this may damage battery packs and potentially cause a fire.

- Inspect charger cord regularly for damage.
- Do not disconnect the off-board charger's DC cord from the machine receptacle when the charger is operating. Arcing may result. If the charger must be interrupted during charging, disconnect the AC power supply cord first.
- Avoid contact with battery acid.
- Keep all metal objects off batteries.
- Use a non-conductive battery removal device.
- Use a hoist and adequate assistance when lifting batteries.
- Battery installation must be done by trained personnel.
- Follow site safety guidelines concerning battery removal.
- All repairs must be performed by a trained service mechanic.
- Do not modify the machine from its original design.
- Use Tennant supplied or approved replacement parts.
- Wear personal protective equipment as needed and where recommended in this manual.



For Safety: wear hearing protection.



For Safety: wear protective gloves.



For Safety: wear eye protection.



For Safety: wear protective dust mask.

6. When using Lithium-ion Battery Model:

- Battery service to be performed by Tennant Service only.
- Battery installation requires a specific service kit which includes a hoisting strap and proper lifting instructions. Contact Tennant Service.
- Do not attempt to lift battery by hand or by any other unauthorized method.
- Battery pack is designed exclusively for specific Tennant machine applications. Do not install battery pack in unapproved machines.
- Dispose of battery in accordance with local regulations. Contact Tennant Service.

- Contact Tennant Service or your local regulatory authorities for proper transporting instructions of lithium-ion batteries.
 - Disconnect battery cable connector, battery management system (BMS) connector and charger cord before working on machine.
 - Use only OEM approved battery charger supplied with lithium-ion battery.
 - Do not expose battery to temperatures below -22°F (-30°C), above 140°F (60°C).
 - Do not use machine immediately after long-term extreme temperature storage. Before use, return battery module temperature range to 50°F (10°C)~95°F (35°C)
 - Do not operate or store battery in hazardous environment (electrically charged, humidity, extreme temperatures and magnetic fields).
 - Do not expose battery to flame or plasma.
 - Do not disassemble or mistreat battery. Do not tear seal tape or will void warranty.
 - Do not drop, crush or subject battery to impact, as it may cause battery to heat up or catch fire.
 - Do not put battery in fire or water to avoid battery explosion.
 - Do not touch battery with wet hand, avoid electric shock.
 - Stop using or charging the battery immediately if battery has abnormal temperature, leakage or other abnormal conditions.
7. When loading/unloading machine onto/off truck or trailer.
- Drain tanks before loading machine.
 - Lower scrub head and squeegee before tying down machine.
 - Turn off machine and remove key.
 - Use ramp, truck or trailer that will support the weight of the machine and operator.
 - Do not load/unload on ramp inclines that exceed 20% (11°) grade.
 - Use winch. Do not push the machine onto/off the truck or trailer unless the load height is 380 mm (15 in) or less from the ground.
 - Block machine tires.
 - Tie machine down to truck or trailer.

SAFETY PRECAUTIONS

The safety labels appear on the machine in the locations indicated. Replace damaged labels.

WARNING LABEL – Flammable materials or reactive metals can cause explosion or fire. Do not pick up.



Located on electrical panel.

WARNING LABEL – Flammable materials can cause explosion or fire. Do not use flammable materials in tank



Located on recovery tank, above solution tank cap.

WARNING LABEL – Batteries emit hydrogen gas. Explosion or fire can result. Keep sparks and open flame away. Keep covers open when charging



Located inside battery compartment on models equipped with wet lead acid (flooded) and sealed AGM batteries.

FOR SAFETY LABEL – Read manual before operating machine.



Located on electrical panel.

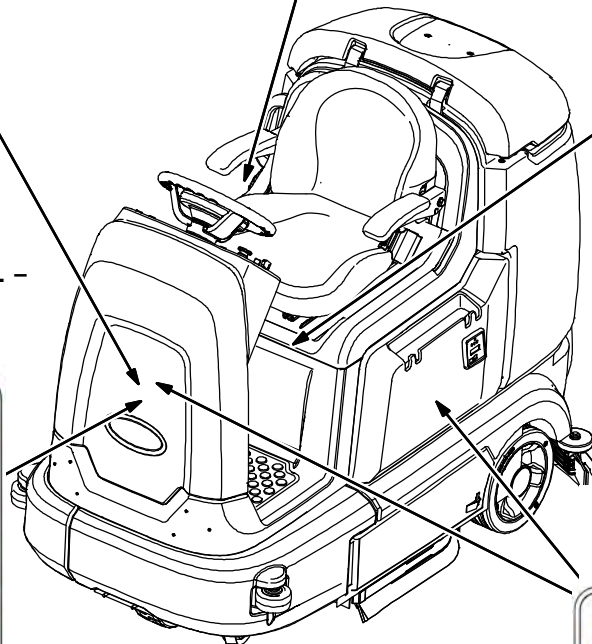

FOR SAFETY LABEL – Authorized Service Mechanic Only.

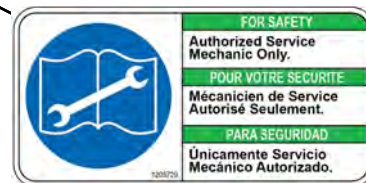

Located on circuit board cover and electrical panel.

Lithium-ion Battery Model: The safety label appears on the lithium-ion battery pack in the location indicated. Replace damaged labels.

LITHIUM-ION BATTERY CAUTION LABEL – Located on top of battery pack.

⚠ CAUTION	⚠ ATTENTION	⚠ ATENCIÓN
<ol style="list-style-type: none">1. Do not expose battery to temperatures below -30° C (-22°F), above 60°C (140°F).2. Do not disassemble or mistreat battery. Do not crush.3. Do not drop or subject it to impact.4. Use only OEM approved charger.5. Failure to follow these instructions may present risk of explosion, fire, or high temperatures.6. See owner's manual for additional safety instructions.7. Recommended torque for stud assembly is; M8 = 9.1Nm / M12 = 24.5Nm.8. Refer to owner's manual for lifting instructions.9. Service by Tennant Personnel only.	<ol style="list-style-type: none">1. No exponga la batería a temperaturas por debajo de -30 ° C (-22°F), por encima de 60 ° C (140 ° F).2. No desarmar ni maltratar la batería. No la aplaste.3. No deje caer ni la someta a impactos.4. Use sólo el cargador Original aprobado.5. El incumplimiento de estas instrucciones puede presentar riesgo de explosión, fuego o altas temperaturas.6. Véase el manual del propietario para instrucciones adicionales de seguridad.7. El par recomendado de apriete para el poste es de; M8 - 9.1Nm / M12 = 24.5Nm.8. Consulte el manual del propietario para las instrucciones de elevación.9. Servicio por técnicos de Tennant exclusivamente.	<ol style="list-style-type: none">1. N'exposez pas la batterie à des températures inférieures à -30 ° C (supérieures à 60 ° C).2. Ne pas démonter ni maltraiter la batterie. Ne pas écraser.3. Ne la laissez pas tomber et ne la soumettez pas à un impact.4. Utilisez uniquement un chargeur approuvé par l'OEM.5. Le non-respect de ces instructions peut présenter un risque d'explosion, d'incendie ou de températures élevées.6. Voir le manuel du propriétaire pour les consignes de sécurité supplémentaires.7. Le couple recommandé pour le montage des goujons est de; M8 - 9.1Nm / M12 = 24.5 Nm.8. Reportez-vous au manuel du propriétaire pour les instructions de levage.9. Service réservé au personnel Tennant.
	Tennant Co File Number: MH63465	 Battery Disposal contact Tennant Technical Service 1-800-553-8033



MACHINE COMPONENTS

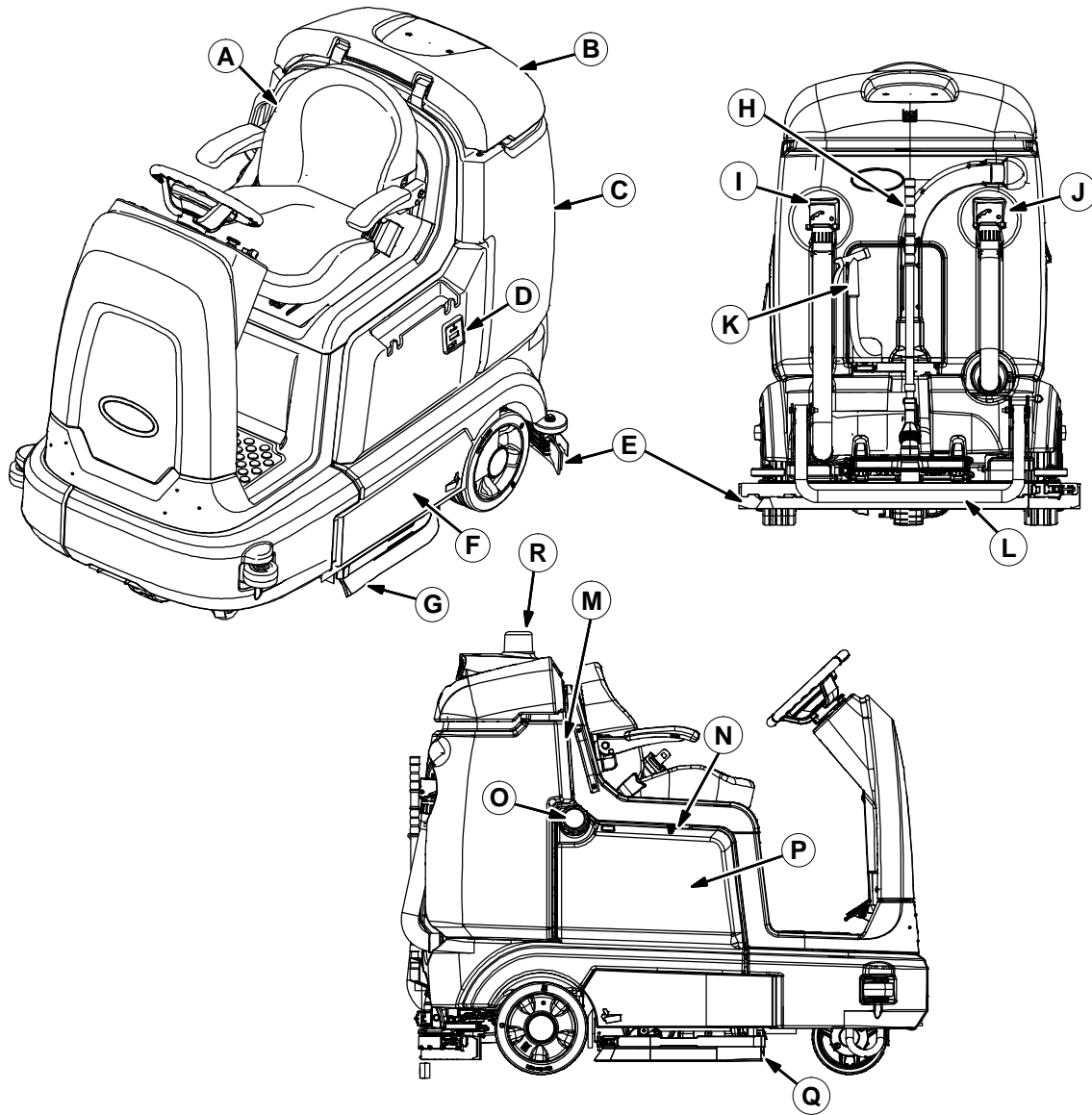

- A. Operator seat
- B. Recovery tank cover
- C. Recovery tank
- D. On-board battery charger (Option)
- E. Rear squeegee
- F. Main brush compartment
- G. Side squeegee

- K. Spray nozzle (Option)
- L. Rear squeegee protector (Option)
- M. ec-H2O System Module compartment (Option) – located behind seat shroud
- N. Battery compartment
- O. Solution tank cap
- P. Solution tank
- Q. Scrub head
- R. Backup alarm / flashing light (Option)

356289 – 356290

CONTROLS AND INSTRUMENTS (T12)



A. Steering wheel

B. Touch panel

C. Propel pedal

D. Brake pedal

E. Spray nozzle switch (Option)

F. Operating lights / hazard lights switch (Option)

G. Side brush switch (Option)

H. Key switch

I. Direction switch

J. Emergency shut-off button

OPERATION

TOUCH PANEL (T12)

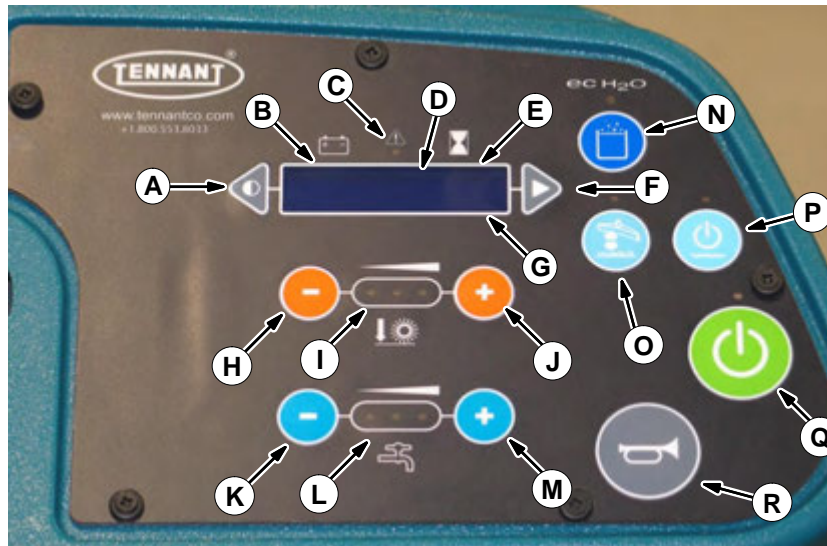

- A. Contrast control button
- B. Battery discharge indicator
- C. Warning / fault indicator light
- D. LCD display
- E. Hour meter
- F. Configuration mode button
- G. Recovery tank full indicator
- H. Brush pressure decrease button (-)
- I. Brush pressure indicator lights
- J. Brush pressure increase button (+)

- K. Solution decrease button (-)
- L. Solution flow indicator lights
- M. Solution increase button (+)
- N. ec-H₂O button
- O. Vacuum fan / squeegee button
- P. Solution On / Off buttons
- Q. 1-Step button
- R. Horn

CONTROLS AND INSTRUMENTS (T12XP)

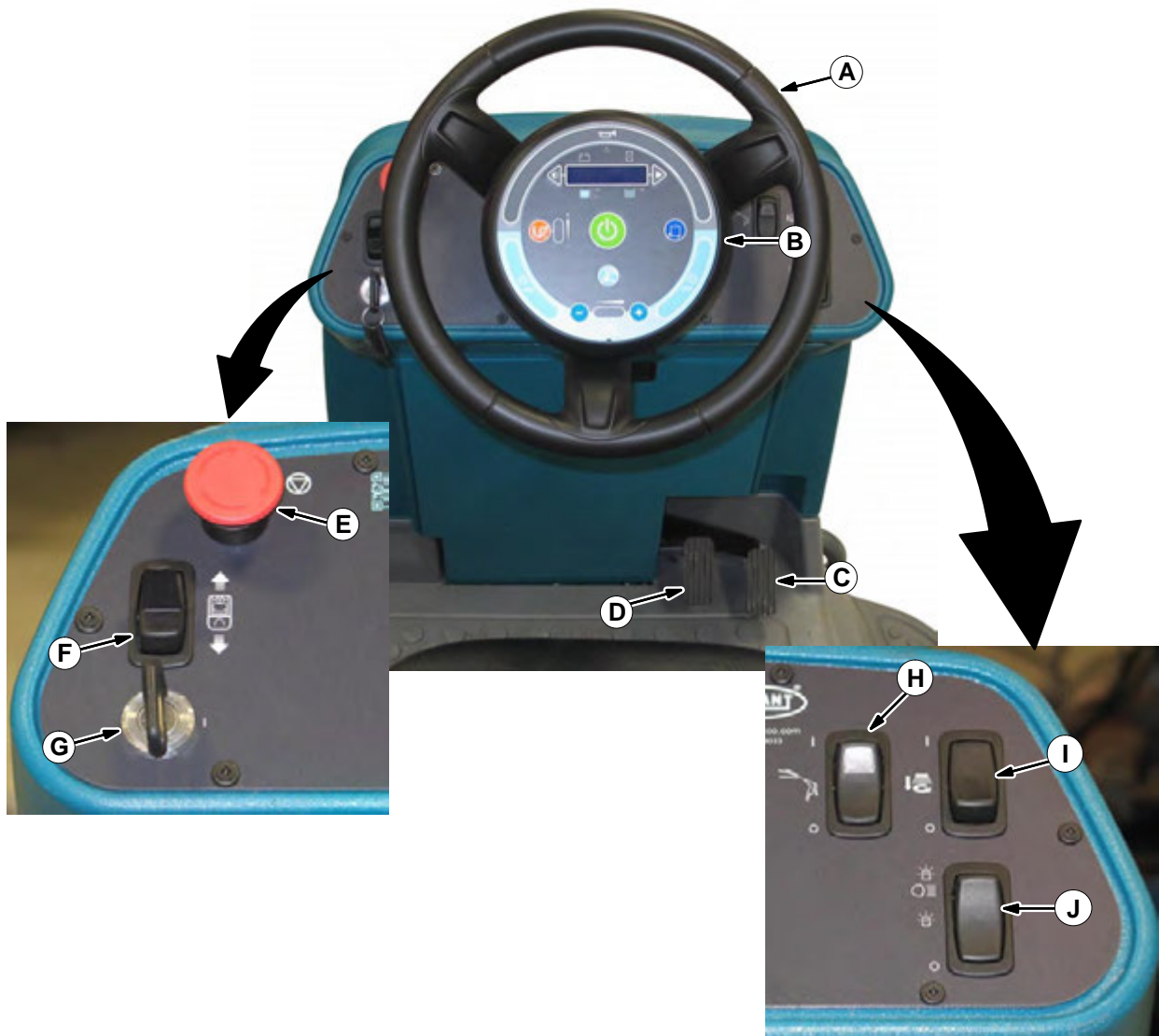

- A. Steering wheel
- B. Touch panel
- C. Propel pedal
- D. Brake pedal
- E. Emergency shut-off button
- F. Directional switch
- G. Key switch
- H. Spray nozzle switch (option)
- I. Side brush switch (option)
- J. Operating lights / hazard lights switch (option)

OPERATION



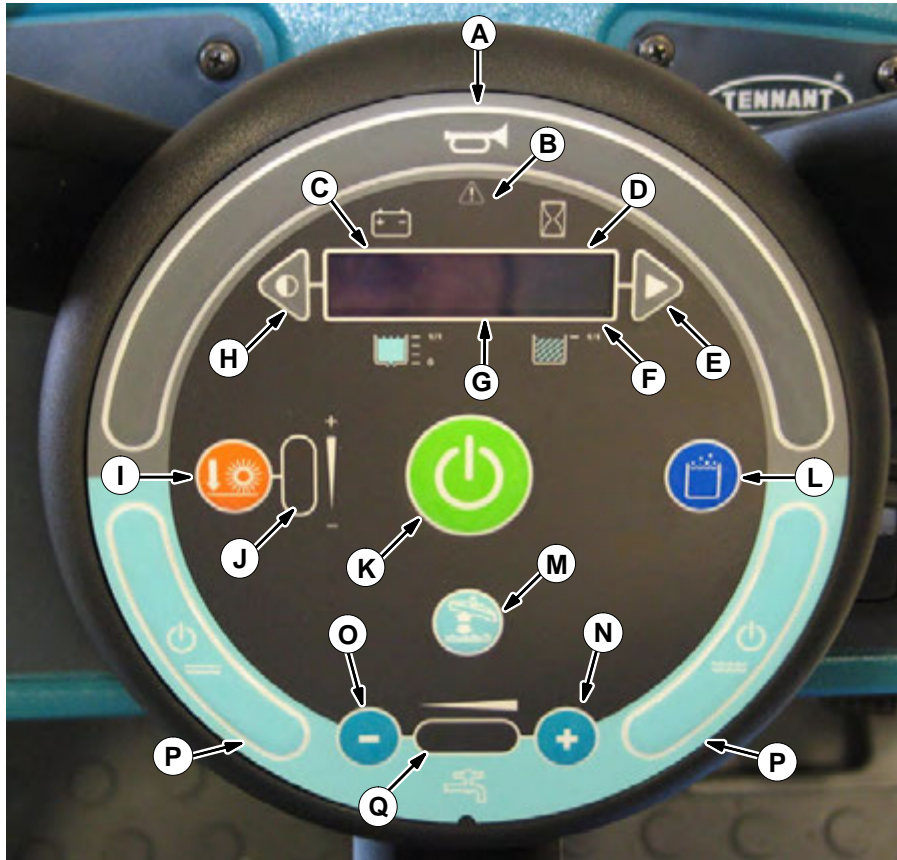













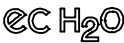







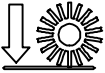



TOUCH PANEL (T12XP)



- A. Horn
- B. Warning / fault indicator light
- C. Battery discharge indicator
- D. Hour meter
- E. Configuration mode button
- F. Recovery tank full indicator
- G. LCD display
- H. Contrast control button
- I. Brush pressure button
- J. Brush pressure indicator lights
- K. 1-Step button
- L. *ec-H2O* button
- M. Vacuum fan / squeegee button
- N. Solution increase button (+)
- O. Solution decrease button (-)
- P. Solution on / off buttons
- Q. Solution flow indicator lights

SYMBOL DEFINITIONS

These symbols are used on the machine to identify controls, displays, and features.

	Fault indicator		Recovery tank
	Vacuum fan / squeegee		Operating lights
	1-STEP		Hazard light
	ec-H2O (option)		Scrub mode
	Solution flow		Circuit breaker
	Increase		Spray nozzle (option)
	Decrease		On
	Main brush pressure		Off
	Side brush (option)		Solution On / Off
	Battery charge		Emergency shut-off
	Horn		Contrast control
	Hour meter		Jack point
	Solution tank		Solution flow (maximum / minimum)
	Forward / Reverse		Brush pressure (maximum / minimum)

OPERATION

INSTALLING BATTERIES

FLOODED/SEALED LEAD-ACID BATTERIES



WARNING: Fire Or Explosion Hazard. Batteries Emit Hydrogen Gas. Keep Sparks And Open Flame Away. Keep Battery Hood Open When Charging.

FOR SAFETY: When servicing machine, wear protective gloves and eye protection when handling batteries and battery cables. Avoid contact with battery acid. Battery installation must be done by trained personnel.

BATTERY SPECIFICATIONS

Six 6-volt deep cycle lead acid batteries.

Maximum battery dimensions: 7 in / 177.8 mm W x 11.8 in / 299.7 mm L x 15 in / 380 mm H.

1. Park the machine on a level surface and remove the key.
2. To engage the seat support, lift the seat completely open until the pin slides into the lower notch of the seat support.

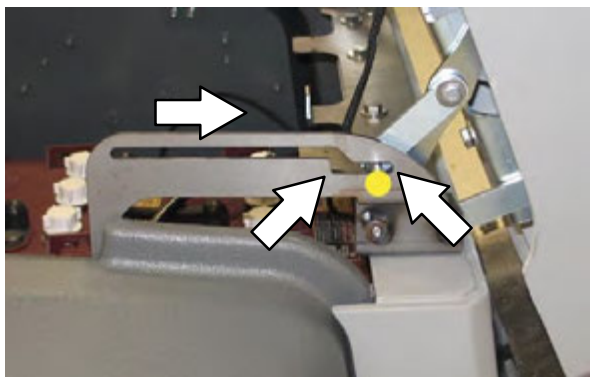

Machines with deluxe seat option only: Pull and hold the *Operator seat release handle* forward to unlock the seat before lifting the seat open.



3. Carefully install the batteries into the battery compartment tray and arrange the battery posts as shown. Insert the foam spacers along side the batteries as shown if installing the smaller batteries.

NOTE: For large traction batteries, remove the seat assembly and use a hoist to install the battery.

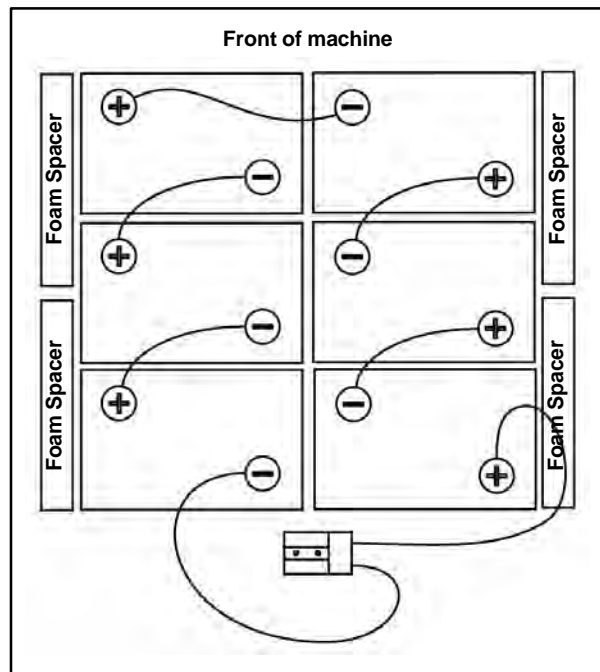

4. Using the supplied battery post boots, connect the cables to the battery posts, RED TO POSITIVE (+) & BLACK TO NEGATIVE (-).

IMPORTANT: Make sure that the charger is properly set for the battery type before charging (See **ON-BOARD CHARGER SETTINGS**).

LITHIUM-ION BATTERY

For machines equipped with lithium-ion battery, contact Tennant Service for battery service and replacement.

FOR SAFETY: When using Lithium-ion Battery Model, battery service to be performed by Tennant personnel only. Battery installation requires a specific service kit which includes a hoisting strap and proper lifting instructions. Contact Tennant Service.

OPERATION OF CONTROLS

BATTERY DISCHARGE INDICATOR

The *Battery discharge indicator* displays the charge level of the batteries while the machine is operating.

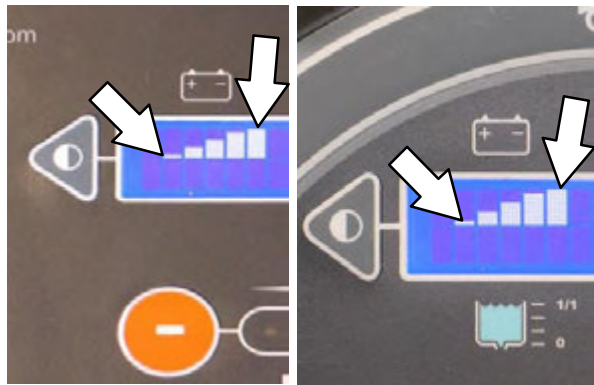

T12

T12XP

When the batteries are fully charged, all five bars are lit. Recharge the batteries when there is only one bar shown in the display. Do not allow the batteries to discharge below the last bar.

NOTE: The reading on the battery discharge indicator is not accurate when the machine is first powered on. Operate the machine a few minutes before reading the charge level of the batteries.

NOTE: The flashing Warning / fault indicator and battery low fault in the LCD (liquid crystal display) will not reset until after the batteries have been fully charged. See FAULT INDICATOR(S).

NOTE: Lithium-ion Battery Model – Do not store the machine for an extended period if battery is discharged to the last bar, the battery may further discharge to a level that is unrecoverable.

HOUR METER

The *Hour meter* records the hours the machine was operated. Use this information to determine machine service intervals.



T12

T12XP

RECOVERY TANK FULL INDICATOR

The *Recovery tank full indicator* displays 0% when the recovery tank is not yet full and 100% when the recovery tank is full. All scrubbing functions will stop when the recovery tank is full. Empty the recovery tank when the indicator displays 100%.



T12

T12XP

OPERATION

EMERGENCY SHUT-OFF BUTTON

The *Emergency shut-off button* immediately stops all power to the machine.

Stop machine power: Push the *Emergency shut-off button*.

Restart machine power: Turn the *Emergency shut-off button* to the right to release the button. Turn the key switch to the Off position, then turn the key fully clockwise and release it to the On position.

NOTE: *Lithium-ion Battery Model* – To restart machine, turn key switch off and wait up to 3 seconds for machine power to completely shut off then turn key switch back on again.



Only use this button in the event of an emergency. It is not intended for routine machine shutdown.

OPERATING / HAZARD LIGHT SWITCH (OPTION)

Operating and Hazard Lights On: Press the top of the *Operating / hazard light switch*.

Hazard Lights On: Press the *Operating / hazard light switch* to the middle position.

All Lights Off: Press the bottom of the *Operating / hazard light switch*.

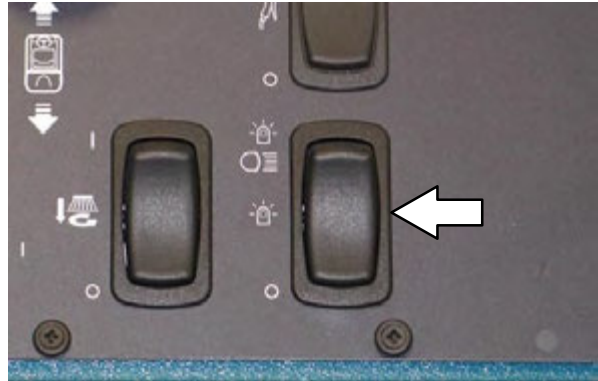

T12

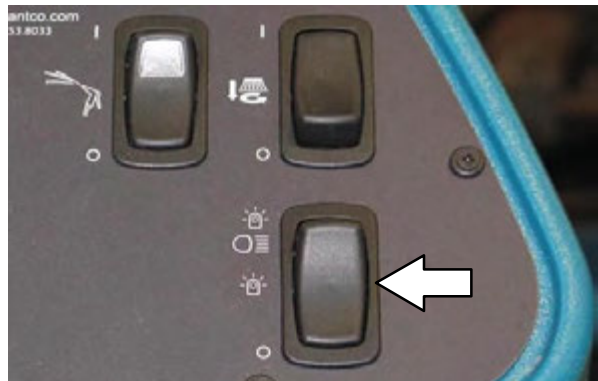

T12XP

OPERATOR SEAT

The front-to-back adjustment lever adjusts the seat position.



SEAT BELTS (Deluxe Seat Option Only)

FOR SAFETY: Before starting machine, adjust seat and fasten seat belt.



SEAT SUPPORT

The *Seat support* holds the seat up to allow access to the batteries and circuit breakers.

To engage the seat support, lift the seat completely open until the pin slides into the lower notch of the seat support.

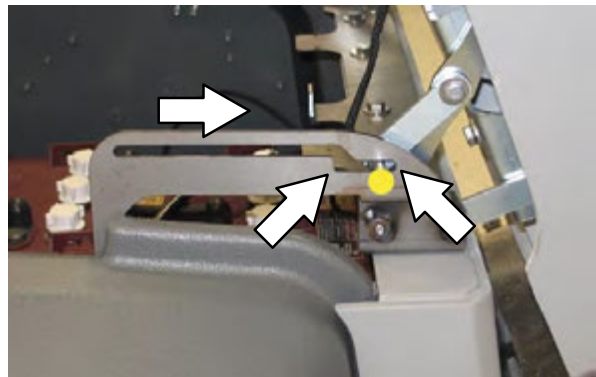

Machines with deluxe seat option only: Pull and hold the *Operator seat release handle* forward to unlock the seat before lifting the seat open.



OPERATION

CONTRAST CONTROL BUTTON

NOTE: The contrast can only be adjusted right after the key switch is turned on.

Use the *Contrast control button* to darken / lighten the LCD display.

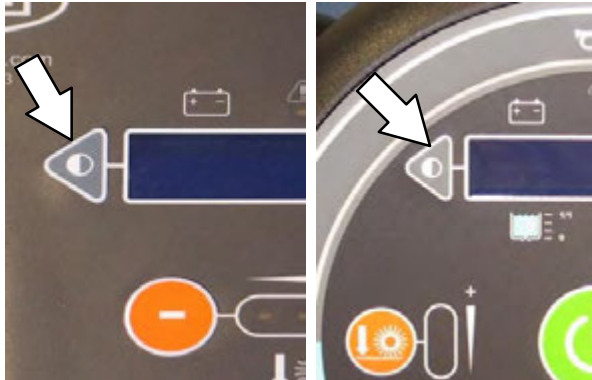

T12

T12XP

CONFIGURATION MODE BUTTON

The *Configuration mode button* is for accessing the configuration and diagnostic modes. Only properly trained service personnel and TENNANT representatives should access these modes.

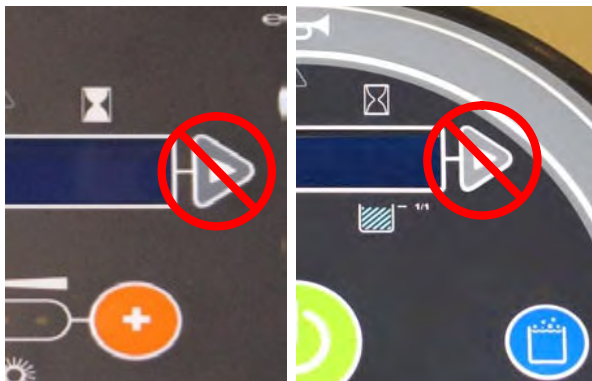

T12

T12XP

PROPEL PEDAL

Press the *Propel pedal* to move the machine.



DIRECTIONAL SWITCH

Use the *Directional switch* to select either the forward or reverse direction. Press the propel pedal to move the machine.



NOTE: An audible alarm will sound when the Directional switch is placed into reverse.

NOTE: Machines equipped with the optional flashing light / backup alarm only: The optional backup light and alarm will function only when the machine is moving in reverse.

BRAKE PEDAL

Press the *Brake pedal* to stop the machine.



VACUUM FAN / SQUEEGEE BUTTON

Lower squeegee and turn vacuum fan on: Press the *Vacuum fan / squeegee button*. The indicator light will illuminate when the squeegee is lowered.

Raise squeegee and turn vacuum fan off: Press the *Vacuum fan / squeegee button*. The indicator light will go out when the squeegee is raised.

NOTE: The 1-STEP button does not need to be activated to operate the vacuum fan / squeegee system. The vacuum fan / squeegee button can be turned on or turned off with the 1-STEP button either on or off.

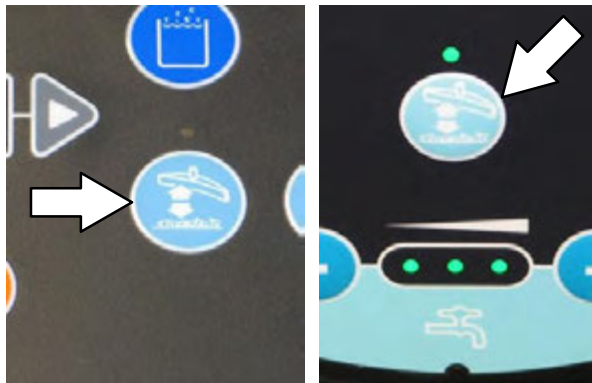

T12

T12XP

SOLUTION ON / OFF BUTTON

Shut off the solution flow: Press the *Solution on / off button* to shut off the solution flow. All the solution flow indicator lights will turn off.

Turn on the solution flow: Press the *Solution on / off button* to turn on the solution flow. The solution indicator lights will turn back on and the solution flow will default to the last setting used.



T12

T12XP

HOW THE MACHINE WORKS



T12 With Cylindrical Brushes



T12 With Disk Brushes

The *1-STEP button* makes it possible to immediately begin scrubbing by operating all the scrubbing functions.

When in the conventional Scrub mode, a water and detergent mixture is used to scrub the floor.

When in the optional *ec-H2O* (electrically converted water) mode, normal water passes through a module where it is oxygenated and charged with an electric current. The electrically converted water changes into a blended acidic and alkaline solution forming a neutral pH cleaner. The converted water attacks the dirt, breaks it into smaller particles, and pulls it off the floor surface allowing the machine to easily scrub away the suspended soil. The converted water then returns to normal water in the recovery tank. The *ec-H2O* system can be used with all double scrubbing and heavy duty scrubbing applications.

OPERATION

BRUSH AND PAD INFORMATION

For best results, use the appropriate brush or pad for the cleaning application. Listed below are brushes and pads and the applications for which each is best suited.

NOTE: The amount and type of soilage play an important role in determining the type of brush or pad to use. Contact a Tennant representative for specific recommendations.

Nylon brush (Disk)* – Softer nylon bristles are recommended for scrubbing coated floors. Cleans without scuffing.

Polyester brush (Cylindrical) – Softer general purpose polyester bristles gently clean while scrubbing. Perfect for sensitive floor surfaces. Polyester does not absorb water so it is preferred over Nylon in wet applications.

PolyPro brush (Cylindrical) – Heavy duty polypropylene bristles provide a more aggressive cleaning performance and can more easily lift compacted dirt, debris, and sand while offering excellent scrubbing performance.

Polypropylene brush (Cylindrical and Disk)* – General purpose polypropylene bristles lift lightly compacted dirt without scuffing high-gloss coated floors.

Super AB brush (Cylindrical and Disk)* – Nylon fiber with an abrasive grit to remove stains and compacted dirt. Aggressive action on any surface. Performs well on buildup, grease, or tire marks.

** This brush is also available for the side brush.*

Stripping pad (Brown)– For stripping of floor finish to prepare the floor for recoating.

Scrubbing pad (Blue) – For medium to heavy-duty scrubbing. Removes dirt, spills, and scuffs.

Buffing pad (Red) – For light duty scrubbing without removing floor finish.

Polishing pad (White) – For maintaining highly polished or burnished floors.

High productivity stripping pad (Black) – For aggressive stripping of heavy finishes or sealers, or for very heavy duty scrubbing. *This pad can only be used with the grip pad driver, not the tufted pad driver.*

Surface preparation pad (Maroon) – For very aggressive chemical free removal of floor finish to prepare the floor for re-coating

Grip pad driver – The grip-face backing allows pads to be fully used and holds pads in place without penetrating the pad. The spring-activated centering device works with all Tennant pads and allows for fast, easy pad replacement.

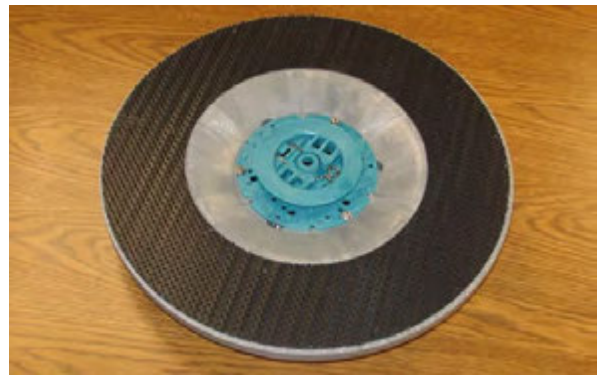

Tufted pad driver – Standard pad driver has short bristles, or “tufts,” on the back to hold the pad in place. This driver works with all Tennant pads except the black high productivity pad.

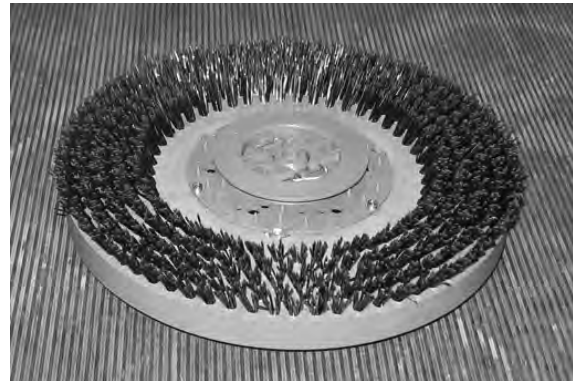

WHILE OPERATING THE MACHINE

Pick up oversized debris before scrubbing. Pick up wire, string, twine, large pieces of wood, or any other debris that could become wrapped around or tangled in the brushes.

Drive in a straight a path as possible. Avoid bumping into posts or scraping the sides of the machine. Overlap the scrub paths by several centimeters (a few inches).

Avoid turning the steering wheel too sharply when the machine is in motion. The machine is very responsive to the movement of the steering wheel. Avoid sudden turns, except in emergencies.

Adjust the machine speed, brush pressure, and solution flow as required when scrubbing. Use the lowest brush pressure and solution flow settings for best performance.

If poor cleaning performance is observed, stop cleaning and refer to *MACHINE TROUBLESHOOTING* in this manual.

Perform the Daily Maintenance Procedures after each use (see *MACHINE MAINTENANCE* in this manual).

Drive the machine slowly on inclines. Use the brake pedal to control machine speed on descending inclines. Scrub with the machine up inclines rather than down inclines.

FOR SAFETY: When using machine, go slowly on inclines and slippery surfaces.

Do not operate machine in areas where the ambient temperature is above 43° C (110° F). Do not operate scrubbing functions in areas where the ambient temperature is below freezing 0° C (32° F).

PRE-OPERATION CHECKLIST

Perform the following steps before operating the machine:

- Check the machine for fluid leaks.
- Check the operating lights.
- Check left side squeegee for wear and damage.
- Check main brushes for wear and damage. Remove wire, string, or twine wrapped around the main scrub brushes.
- Machines equipped with cylindrical brushes: Confirm the debris tray is empty and clean.
- Machines equipped with side brush option: Check for wire, string, or twine wrapped around the scrub brush.
- Machines equipped with side brush option: Check squeegee for wear and damage.
- Check the rear squeegees for wear and damage.
- Check the recovery tank cover seals for wear or damage.
- Confirm the vacuum fan inlet filter is clean.
- Check the right side squeegee for wear and damage.
- ec-H2O* Scrubbing: Confirm all conventional cleaning agents/restorers are drained and rinsed from the solution tank.
- ec-H2O* Scrubbing: Confirm the solution tank is filled with **clear cool water only**.
- Check the horn, headlights, taillights, safety lights, and backup alarm (if equipped).
- Check the brakes and steering for proper operation.
- Check the tires for damage.
- Check maintenance records to determine maintenance requirements.

OPERATION

STARTING THE MACHINE

FOR SAFETY: Before starting machine, adjust seat and fasten seat belt (if equipped).

1. Sit in the operators seat.
2. Turn the *Key switch* completely past the On position and release the key switch. The key switch will automatically return to the On position.

NOTE: Lithium-ion Battery Model – It is not required to turn the key switch completely past the On position to start machine. However, there is a slight delay before the machine power turns on after turning key switch. There is also a 3 second delay when powering off the machine.

NOTE: Lithium-ion Battery Model – The machine will automatically shut off if not operated for more than one hour to conserve battery energy. To restart machine, turn key switch off and wait up to 3 seconds before turning key switch back again.

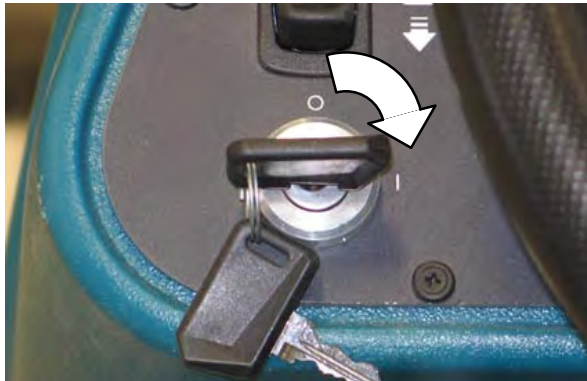

3. Turn on lights (if equipped).
4. Place the *Directional switch* into the direction needed to travel.
5. Press the *Propel pedal* to move the machine.

NOTE: The machine will not travel unless the operator is sitting in the operator seat.

FILLING THE SOLUTION TANK

ec-H2O SCRUBBING (*ec-H2O* MODE)

FOR SAFETY: Before leaving or servicing machine, stop on level surface, turn off machine, and remove key.

1. Remove the cap from the solution tank.

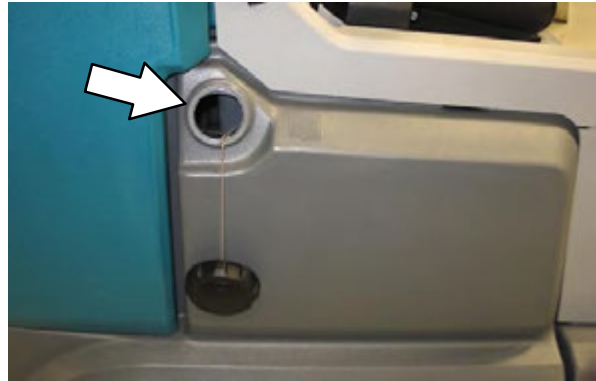

2. Fill the solution tank with only clean COOL WATER (less than 21°C / 70°F). DO NOT use hot water or add any conventional floor cleaning detergents or an *ec-H2O* system failure may result. Fill the solution tank with water until the level is approximately 50 mm (2 in) below the cap.

WARNING: Flammable materials can cause an explosion or fire. Do not use flammable materials in tank(s).

*NOTE: Do not use the *ec-H2O* system when there are conventional cleaning detergents in the solution tank. Drain, rinse, and refill the solution tank with clear cool water before operating the *ec-H2O* system. Conventional cleaning detergents may cause an *ec-H2O* system failure.*

3. Reinstall the cap onto the solution tank.

CONVENTIONAL SCRUBBING MODE

FOR SAFETY: Before leaving or servicing machine, stop on level surface, turn off machine, and remove key.

1. Open the solution tank cover.

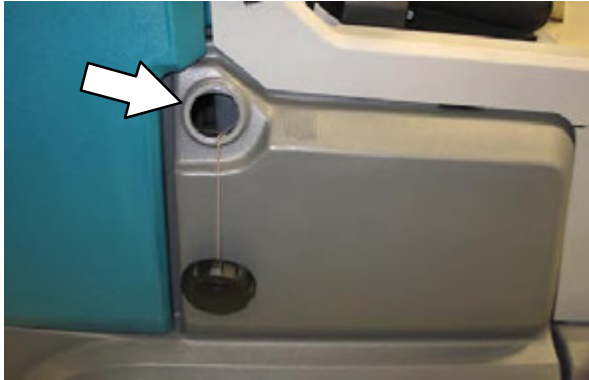

2. Partially fill solution tank with water (not to exceed 60°C / 140°F). Pour the required amount of detergent into the solution tank. Continue filling the solution tank with water until the level is approximately 50 mm (2 in) below the cap.

WARNING: Flammable materials can cause an explosion or fire. Do not use flammable materials in tank(s).

ATTENTION: For Conventional Scrubbing, only use recommended cleaning detergents. Machine damage due to improper detergent usage will void the manufacturer warranty.

NOTE: Pour a recommended foam control solution into the recovery tank if excessive foam appears. For specific detergent recommendations, contact a Tennant representative.

3. Close the solution tank cover.

ec-H2O BUTTON (OPTION)

The *ec-H2O button* enables the *ec-H2O system* to come on when the *1-STEP button* is activated. The light between the *ec-H2O logo* and *ec-H2O button* will come on. The machine will default to the last setting used when it is powered on or off.



T12

T12XP

OPERATION

SETTING BRUSH PRESSURE

Under normal cleaning conditions, the brush pressure should be set to the lowest setting. Under heavy grime conditions, the brush pressure can be set to a higher setting. Travel speed and floor conditions will affect cleaning performance. If brushes are worn, it may be necessary to increase the brush pressure. The machine will default to the last setting used when it is powered on or off.

T12 Only: With the *1-STEP button* activated, press either the *Brush pressure increase button (+)* or *Brush pressure decrease button (-)* to set the brush pressure.

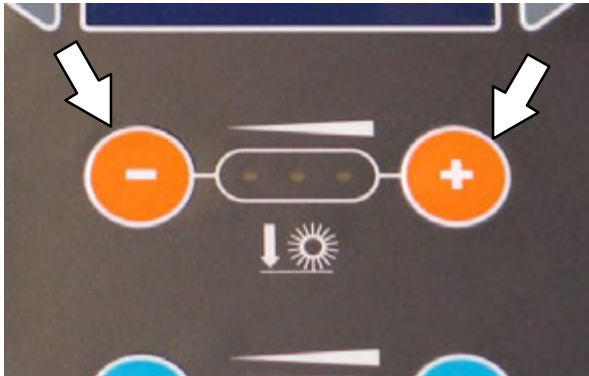

T12

T12XP Only: With the *1-STEP button* activated, press the *Brush pressure button* to both raise or lower the brush pressure settings.



T12XP

SETTING SOLUTION FLOW

With the *1-STEP button* activated, press either *Solution increase button (+)* or *Solution decrease button (-)* to set the solution flow level. Travel speed and floor conditions will affect scrubbing performance. Under normal soilage conditions the solution flow level should be set to the lowest setting (the left light). Under heavy grime conditions, the solution flow level should be set to the higher settings (middle or right lights). The machine will default to the last setting used when the machine is powered on or off. The solution flow indicator lights display the current solution flow setting.

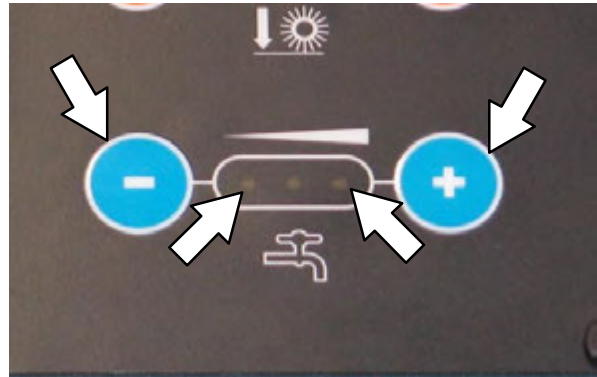

T12



T12XP

SCRUBBING

FOR SAFETY: Do not operate machine, unless operator manual is read and understood.

1. Turn on the machine.
2. Press the *1-STEP button*. The light near the button will come on. All the preset scrubbing functions will turn on.



T12

T12XP

3. Press the *ec-H2O button* if using optional *ec-H2O system* to scrub. The indicator light will illuminate.



T12

T12XP

4. If necessary, adjust the brush pressure and solution flow.

5. Place the *Directional switch* in the direction the machine is to be moved (forward or reverse).

6. Press the *Propel pedal* to begin scrubbing.

NOTE: DO NOT turn on the ec-H2O system during conventional scrubbing. Conventional cleaning detergents could cause an ec-H2O system failure. Drain, rinse, and refill the solution tank with cool clean water before operating the ec-H2O system.

WARNING: Flammable materials or reactive metals can cause an explosion or fire. Do not pick up.

FOR SAFETY: When using machine, go slowly on inclines and slippery surfaces.

NOTE: The squeegee automatically rises when the machine is driven in reverse. This prevents damage to the squeegee.

ec-H2O Model: If an alarm sounds and the warning / fault indicator indicator light flashes the *ec-H2O* module must be flushed to resume *ec-H2O* operation (See *ec-H2O MODULE FLUSH PROCEDURE*).

NOTE: When the alarm sounds press the scrub mode button to shut off the ec-H2O system and continue scrubbing or flush the ec-H2O system.

ec-H2O SYSTEM INDICATOR LIGHT CODE	CONDITION
Solid blue indicator light	Normal operation
Flashing red warning / fault indicator light	Flush <i>ec-H2O</i> module
Solid red warning / fault indicator light	Contact Service Center

7. Release the *Directional pedal* and press the *brake pedal* to stop the machine.

8. Press the *1-STEP button* to stop scrubbing. The light near the button will go off and scrubbing functions will stop after a short delay.

OPERATION

DOUBLE SCRUBBING

Use the double scrubbing method to clean heavily soiled areas.

Double scrubbing can be performed using the *ec-H2O* SCRUBBING SYSTEM (option) or CONVENTIONAL SCRUBBING methods.

To raise the side squeegees for double scrubbing, remove the clevis pins from the storage locations. Manually raise both side squeegee assemblies, then reinsert the pins into the holes in the side squeegee brackets.



Press the *1-STEP* button and then the *Vacuum fan/squeegee* button. The light above the *Vacuum fan/squeegee* button will turn off, the squeegee will rise, and the vacuum fan will stop operating. Scrub the heavily soiled area. Let the cleaning solution soak on the floor for 5–15 minutes.

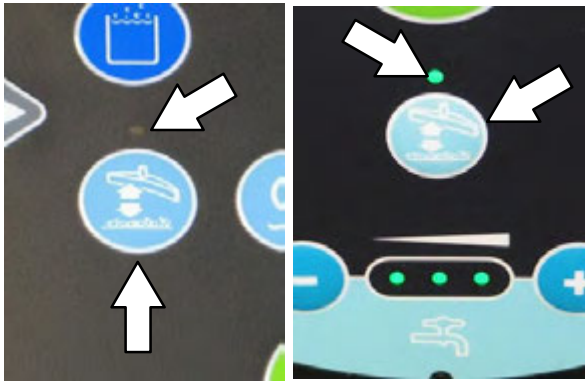

T12

T12XP

FOR SAFETY: When using machine, go slowly on inclines and slippery surfaces.

Before scrubbing the floor a second time, lower the side squeegees and press the *Vacuum fan/squeegee* button to lower the rear squeegee and turn on the vacuum fan. The light above the button will come on. Scrub the floor a second time to pick up the cleaning solution.



WARNING: Flammable materials or reactive metals can cause an explosion or fire. Do not pick up.

NOTE: To turn off the solution flow when scrubbing the area a second time, press the *Solution on / off* button. Press the *Solution on / off* button again to restart the solution flow.



T12

T12XP

NOTE: Double scrubbing is not recommended in areas where the cleaning solution will run under racks or damage products.

WATER PICKUP MODE (NO SCRUBBING)

The machine can be used to pick up water or non-flammable liquid spills without scrubbing.

To pick up water or non-flammable liquid spills, make sure the *1-STEP button* is not activated. The light above the button must be off.



T12

T12XP

⚠ WARNING: Flammable materials or reactive metals can cause an explosion or fire. Do not pick up.

Press the *Vacuum fan/squeegee button*. The light above the button will come on, the squeegee will lower, and the vacuum fan will start operating. Pick up the water or non-flammable liquid spill.

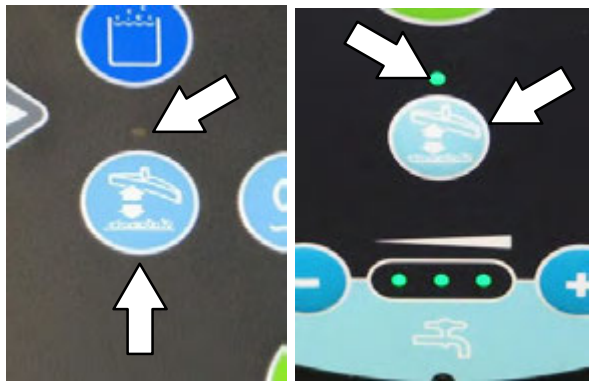

T12

T12XP

STOP SCRUBBING

1. While the machine is still in motion, press the *1-Step button* to stop the scrubbing operations. The squeegee will briefly remain lowered to the floor to pick up the water in the scrub head, and then raises.



T12

T12XP

2. Release the *Propel pedal* and press the *Brake pedal* to stop the machine.

OPERATION

DRAINING AND CLEANING THE RECOVERY TANK

Drain and clean the recovery tank daily or when the recovery tank full fault code appears on the LCD display.

Clean the outside of the tank with vinyl cleaner.

1. Drive the machine near a floor drain.

FOR SAFETY: Before leaving or servicing machine, stop on level surface, turn off machine, and remove key.

2. Unhook the recovery tank drain hose from the recovery tank.



3. Hold the drain hose near a floor drain, twist the drain nozzle open, and place the hose near the floor drain.

NOTE: Be sure the drain hose nozzle is pointed in a safe direction before opening the nozzle.



4. If necessary, twist the drain nozzle to another position to adjust the flow rate.

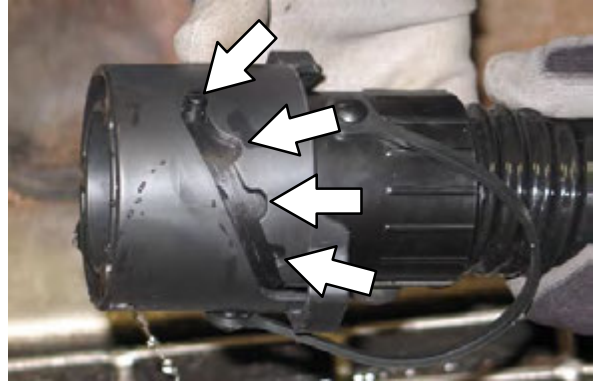

5. Lift the recovery tank cover and flush out the recovery tank with clean water. Rinse the sensor near the top of the tank.

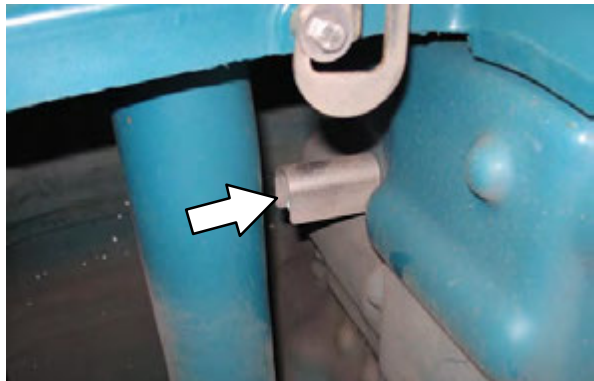

6. To prevent leaks, clean the plug portion of the nozzle and the interior of the drain hose cuff.



NOTE: DO NOT use steam to clean the tanks. Excessive heat can damage the tanks and components.

7. Twist the drain cuff closed and insert the drain hose back into the clip on the recovery tank.



8. Check the vacuum fan inlet filter daily. Clean inlet filter with a damp cloth or hose when dirty. Allow filter to completely dry before reinstalling it into the machine.



9. Remove the vacuum screen from the recovery tank and rinse the screen.



10. Remove the debris tray from the recovery tank and rinse all debris from the tray.



11. Close the recovery tank cover.

12. Cylindrical scrub head: Remove and clean the debris trough. Place the trough back in the scrub head when clean.



NOTE: The scrub head must be lowered approximately 25 mm (1 in) to remove debris trough.

NOTE: The debris trough can be removed from the right side of the machine only.

OPERATION

DRAINING AND CLEANING THE SOLUTION TANK

Clean the outside of the tank with vinyl cleaner.

1. Drive the machine near a floor drain.

FOR SAFETY: Before leaving or servicing machine, stop on level surface, turn off machine, and remove key.

2. Remove the solution tank drain hose from the solution tank.



3. Hold the drain hose near a floor drain, twist the drain nozzle open, and place the hose near the floor drain.

NOTE: Be sure the drain hose nozzle is pointed in a safe direction before opening the nozzle.



4. If necessary, twist the drain nozzle to another position to adjust the flow rate.

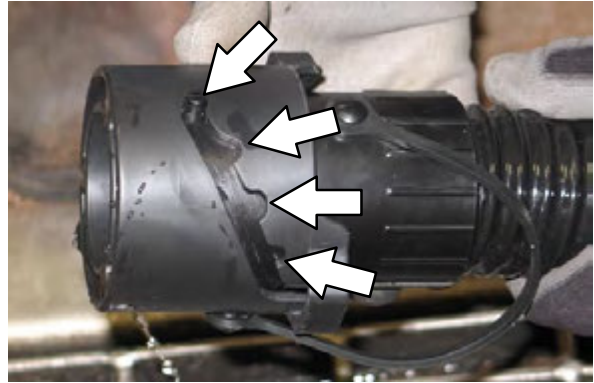

5. Remove the cap from the solution tank and flush out the solution tank with clean water.

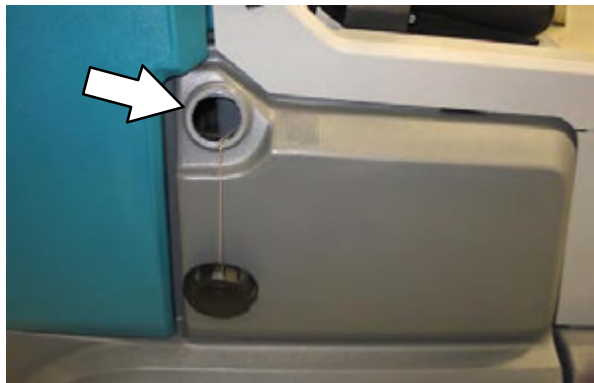

*NOTE: **DO NOT** use steam to clean the tanks. Excessive heat can damage the tanks and components.*

6. To prevent leaks, clean the plug portion of the nozzle and the interior of the drain hose cuff.



7. Twist the drain cuff closed and insert the drain hose back into the clip on the recovery tank.



8. If the solution tank filter gets clogged, remove the drain hose to access and clean the filter.

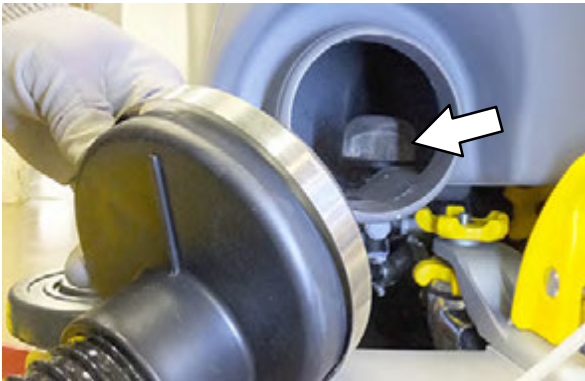

TURN OFF THE MACHINE

1. Remove foot from the *Propel pedal*.
2. Press the *1-Step button* to stop scrubbing.
3. Press the *Brake pedal* to stop the machine.
4. Turn the *Key switch* to the Off position.

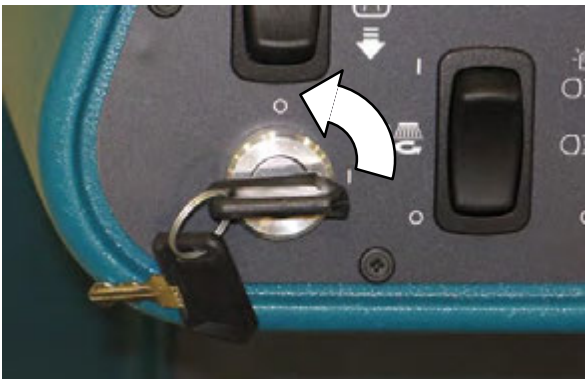

OPERATION

FAULT INDICATOR(S)

This machine is equipped with two visual indicators, a red indicator light and an LCD (liquid crystal display).

The red indicator light will blink continuously indicating that a fault has occurred.

The LCD will display a fault code. If there is more than one fault, each fault code will alternately display.

All faults codes are also accompanied by an audible alarm to alert the operator a fault has occurred.

To reset the fault indicators, turn the machine off, then eliminate the cause of the fault. The fault indicator will reset when the machine is restarted.

NOTE: Lithium-ion Battery Model – To clear fault code, turn the key switch off and wait up to 3 seconds for machine power to completely shut off. Then turn key switch back on again.

Refer to the table below to determine the cause and remedy for the fault.

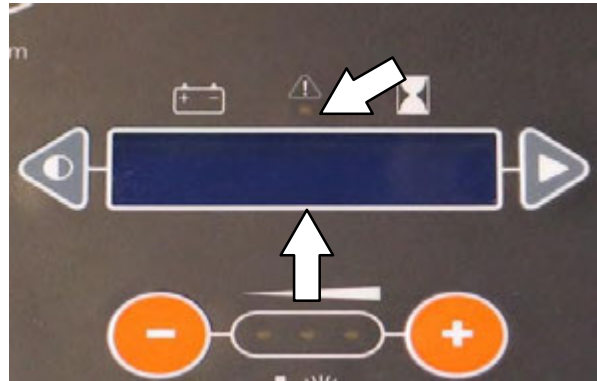

T12

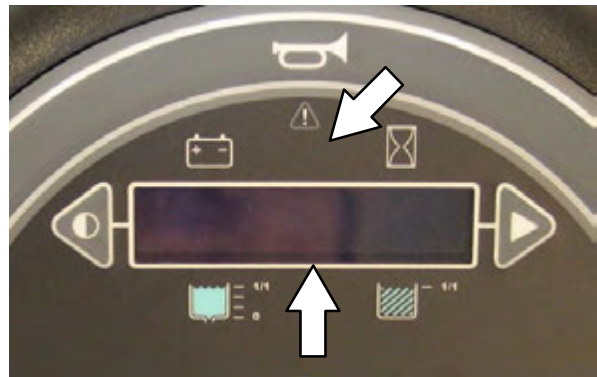

T12XP

Fault Code (Displayed in LCD)	Cause(s)	Remedy
F1:Rcv Tank Full	Recovery tank is full	Empty recovery tank
F2: Sol Tank Empty	Solution tank is empty	Fill solution tank.
F3: Vac # Flt #	Vacuum fan motor(s) not operating	Shut off and restart machine. If fault code still appears, stop using machine and contact Tennant service representative.
F4: Batt Very Low	Low battery charge	Recharge battery
F5: Propel Error	Propel controller error	Turn off and restart machine.
F6: Left Br Flt #	Left brush not operating	If fault code still appears, stop using machine and contact Tennant service representative.
F6: Frnt Br Flt#	Front brush not operating	
F7: Rght Br Flt#	Right brush not operating	
F7: Rear Br Flt#	Rear brush not operating	
F8: Hi B3 Current	Side brush not operating	
F9: Pickup Error	Vacuum not operating	
F10: Scrub Error	Scrub head not operating	
F12: Check Brushes	Brushes not operating	
F14: ec-H2O Error	ec-H2O system not operating	

WARNING CODES

Warning codes are typically caused by the operator attempting to activate modes that are not available. The warning code will appear in the LCD (liquid crystal display).

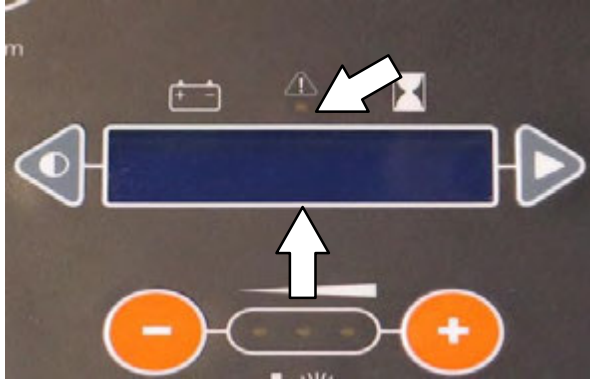

T12

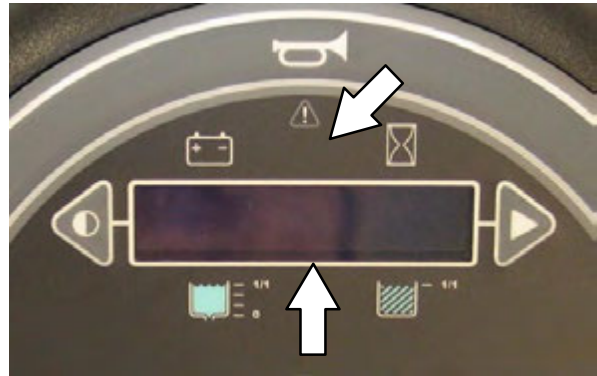

T12XP

Refer to the table below to determine the cause of the warning code.

Warning Code (Displayed in LCD)	Cause(s)	Remedy
W1: Batt. Low	Low battery charge	Charge batteries
W2: Sqge Stall	Rear squeegee not lowering	Check squeegee / squeegee actuator for obstructions or damage
W3: Side Stall	Side brush not lowering	Check side brush actuator for obstructions
W4: Unavailable	Optional solution not enabled	Solution mode not available
W5: No Side Brush	Side brush not enabled	Side brush not available
W6: Ec Offline	ec-H ₂ O system not operating	Turn off and restart machine. If warning code still appears, stop using machine and contact Tennant service representative.
W7: Not Active	Button inactive	Button not active for use
W8: No Vac. Amps	Vacuum fan not operating	Check harness connection. Reconnect harness if it is unconnected.
W9: Open R/R Brush	Right / rear brush not operating	If warning code still appears, stop using machine and contact a Tennant service representative.
W10: Open L/F Brush	Left / front brush not operating	
W11: Open SD Brush	Side brush not operating	
W12: Solution Off	No solution flow to scrub head	Press <i>Solution on / off button</i> to start solution flow.
W13: Side Offline	Side brush not operating	Turn off and restart machine. If warning code still appears, stop using machine and contact Tennant service representative.

OPERATION

OPTIONS

SPRAY NOZZLE (OPTION)

The spray nozzle is used to clean the machine and surrounding areas. The solution tank provides a water/solution supply for the spray nozzle.

FOR SAFETY: When servicing machine, do not power spray or hose off machine near electrical components.

FOR SAFETY: Before leaving or servicing machine and stop on level surface.

1. Turn on the machine.
2. Press the top of the *Spray nozzle switch* to turn on the spray nozzle. The light on the switch will come on when the spray nozzle is turned on.



T12



T12XP

3. Pull the spray nozzle out from the back of the machine and clean as needed.



4. When finished cleaning, gently pull the hose and allow the spray nozzle hose to retract back into the machine.

NOTE: Continue holding onto the spray nozzle and control the hose while it is retracting back into the machine. The machine and / or the spray nozzle assembly could be damaged if the spray nozzle hose is released and allowed to rapidly retract into the machine.

5. Place the spray nozzle onto the hook.

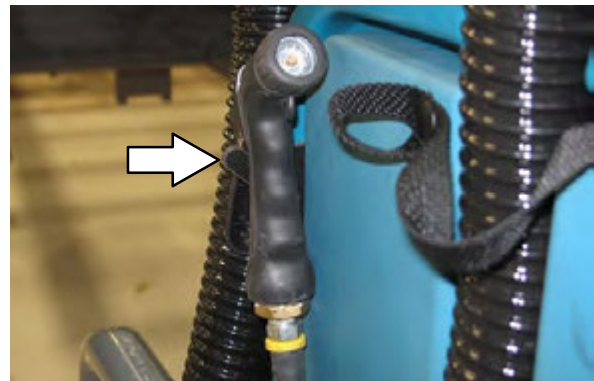

6. Press the bottom of the *Spray nozzle switch* to turn off the water supply. The light on the switch will turn off when the spray nozzle is turned off.

NOTE: Be sure the Spray nozzle switch is turned off before continuing scrubbing. The spray nozzle pump could be damaged if the switch is left on while scrubbing.

VACUUM WAND (OPTION)

Use the vacuum wand to clean areas that are out of reach of the machine.

WARNING: Flammable materials or reactive metals can cause an explosion or fire. Do not pick up.

1. Unsnap the vacuum wand lanyard from the solution tank.



2. Remove the vacuum wand / squeegee vacuum hose from the rear squeegee.



3. Insert the vacuum wand cap into the vacuum port in the vacuum wand.



4. Twist the vacuum nozzle to the vacuum position and extend the handle to the desired length.



5. Turn on the machine.
6. Press the *Vacuum fan/squeegee button* to turn on the vacuum fan. The squeegee will completely lower.

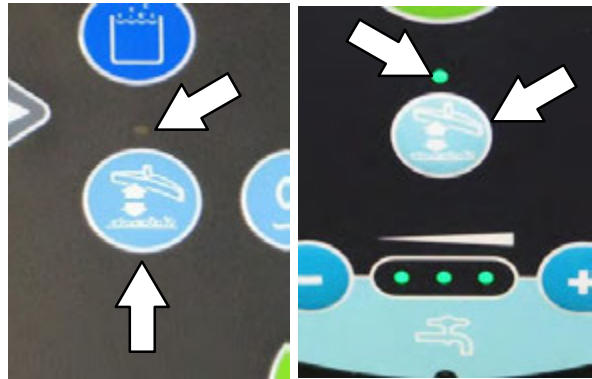

T12

T12XP

7. Vacuum the floor.



OPERATION

- When finished vacuuming, press the *Vacuum fan/squeegee button* to turn off the vacuum fan. The squeegee will raise.
- Turn off the machine.
- Remove the vacuum wand cap from the vacuum port and return the vacuum nozzle to the storage position and the handle to the storage length.



- Reinstall the vacuum wand / squeegee vacuum hose onto the rear squeegee.
- Insert the vacuum hose into the vacuum hose recess in the recovery tank.



- Snap the vacuum wand lanyard onto the solution tank to secure the vacuum wand / squeegee vacuum hose to the machine.

REAR SQUEEGEE GUARD (OPTION)

The rear squeegee protector helps protect the rear squeegee from being damaged.



To engage the rear squeegee protector, pull the pin, lower the protector bar, and reinsert the pin.



SIDE BRUSH (OPTION)

The side brush moves debris into the path of the main brushes.

WARNING: Flammable materials or reactive metals can cause an explosion or fire. Do not pick up.

1. Turn on the machine
2. Press the top of the *Side brush switch* to enable the side brush assembly.

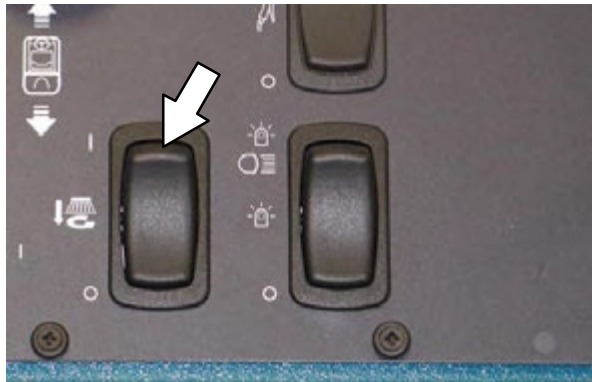

T12

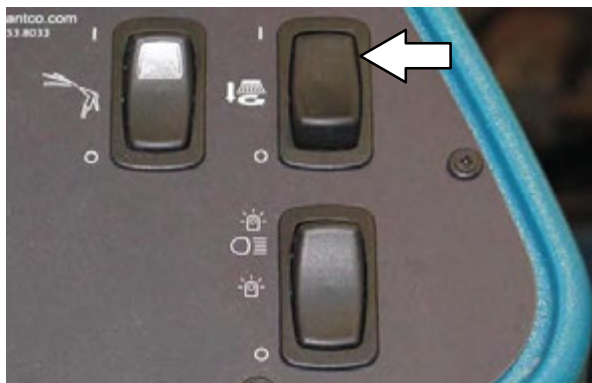

T12XP

3. Press the *1-Step button*. The side brush assembly will lower with the main brush.

NOTE: The 1-Step button controls the side brush assembly when the Side brush switch is in the On (top) position.

4. Press the *Propel pedal* to begin scrubbing.
5. Press the bottom of the *Side brush switch* to stop and raise the side brush.

ADJUSTING BACKUP ALARM VOLUME (OPTION)

FOR SAFETY: When using machine, follow site safety guidelines concerning backup alarms.

The backup alarm volume can be adjusted from 85–102 dB(A). To adjust the volume, remove the backup alarm cover and turn the volume knob.

Increase volume: Turn the knob clockwise.

Decrease volume: Turn the knob counter-clockwise.

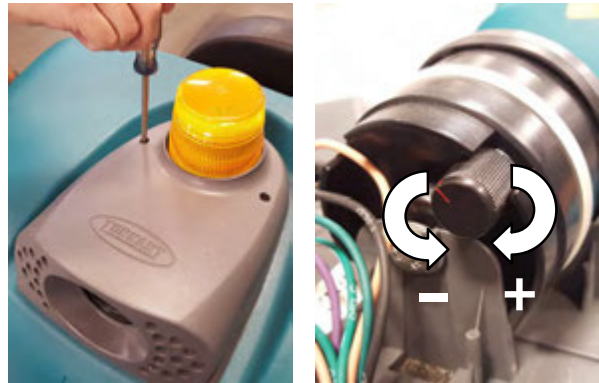

OPERATION

MACHINE TROUBLESHOOTING

Problem	Cause	Remedy
Machine will not operate	Emergency stop button activated	Turn button clockwise to reset
	Machine fault detected	See FAULT INDICATORS or WARNING CODES
	Discharged batteries	Charge batteries
	Loose battery cable(s)	Tighten loose cable(s)
	Faulty battery(s)	Replace battery(s)
	Faulty key switch	Contact Tennant service representative
	Faulty control board	Contact Tennant service representative
On-board battery charger will not operate	Plug not connected to power supply	Check plug connection
	Faulty charger fuse	Replace charger fuse
	Faulty power supply chord	Replace power supply chord
	Error detected	See ON-BOARD BATTERY CHARGER ERROR CODES
Trailing water – poor or no water pickup	Worn squeegee blades	Rotate or replace squeegee blades
	Squeegee out of adjustment	Adjust squeegee
	Clogged squeegee assembly	Clean squeegee assembly
	Vacuum hose loose	Secure vacuum hose connections
	Vacuum hose clogged	Flush vacuum hose
	Vacuum hose damaged	Replace vacuum hose
	Vacuum fan inlet filter dirty	Clean inlet filter
	Debris caught on squeegee	Remove debris from squeegee
	Vacuum hose to squeegee or recovery tank disconnected or damaged	Reconnect or replace vacuum hose
	Tank cover not completely closed	Check for obstructions
	Torn seals on recovery tank	Replace seals
	Vacuum fan will not turn on	Recovery tank full
Foam filling recovery tank		Empty recovery tank
		Use less or change detergent
		Use a defoamer
Little or no solution flow to the floor	Solution tank empty	Fill solution tank
	Solution flow turned off	Turn solution flow on
	Solution supply lines plugged	Flush solution supply lines
	Solution solenoid clogged or stuck	Clean or replace
	Solution tank filter clogged	Clean filter

Problem	Cause	Remedy
Poor scrubbing performance	Debris caught on scrub brushes	Remove debris from brushes
	Improper detergent / brushes pads used	Contact Tennant representative for recommendations
	Worn scrub brushes pads	Replace scrub brushes / pads
	Excessive brush pressure	Reduce scrub brush down pressure
	Uneven brush pressure	Level scrub head
	Debris trough full	Empty debris trough
	Broken brush drive belts on cylindrical scrub head	Replace belts
	Low battery charge	Charge batteries until the charger automatically turns off
Reduced run time	Batteries not fully charged	Charge batteries until the charger automatically turns off
	Defective battery(s)	Replace battery(s)
	Batteries need maintenance	See BATTERIES in MAINTENANCE
	Faulty battery charger	Replace battery charger
ec-H2O Model: Warning and fault indicator light blinking red	Mineral deposit build-up in module	Flush module (See <i>ec-H2O</i> MODULE FLUSH PROCEDURE)
ec-H2O Model: Warning and fault indicator light solid red	Clogged module	Contact Tennant service representative
	Defective solution pump	Replace solution pump

MAINTENANCE

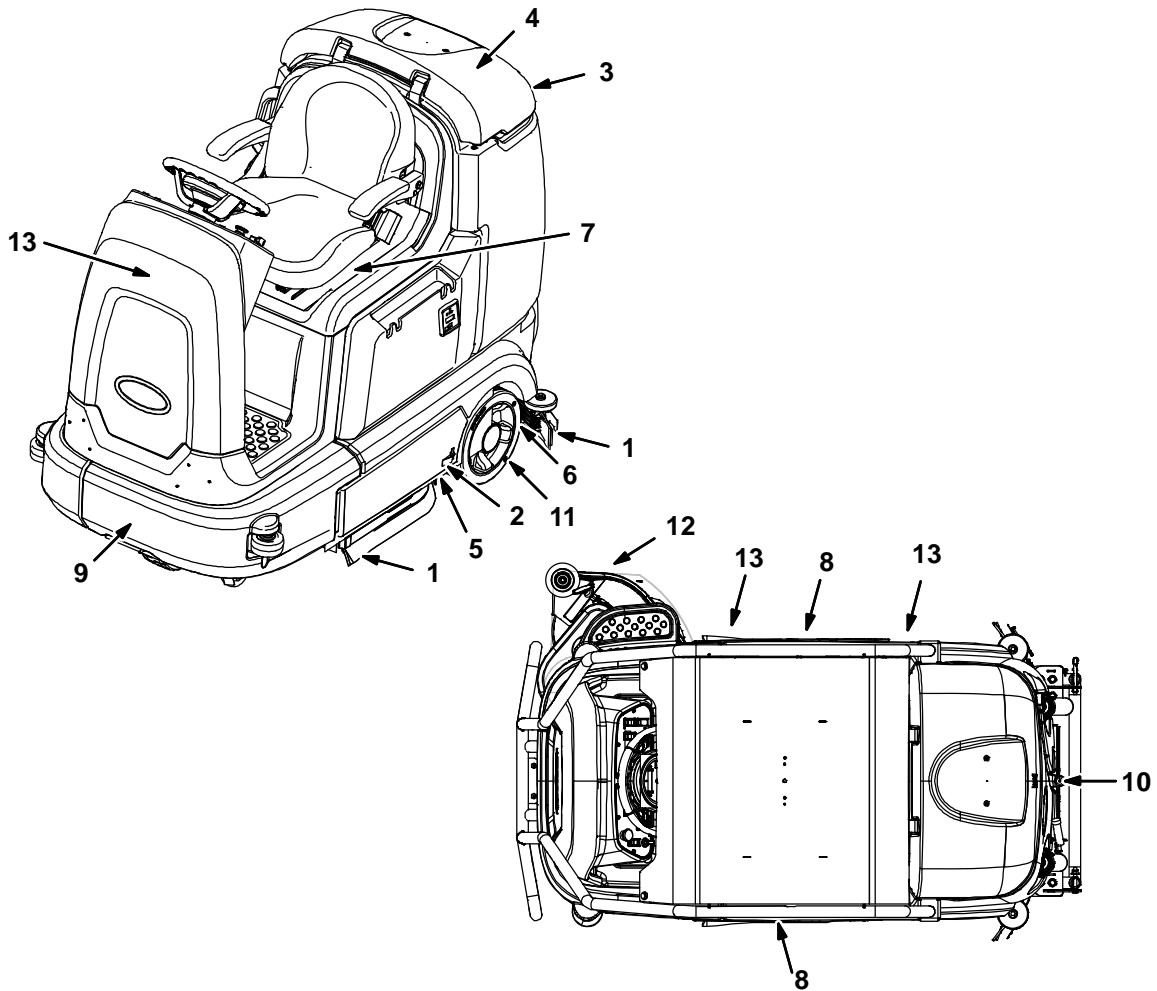

356389 356290

MAINTENANCE CHART

The table below indicates the *Person Responsible* for each procedure.

O = Operator.

T = Trained Personnel.

Interval	Person Resp.	Key	Description	Procedure	Lubricant/ Fluid	No. of Service Points
Daily	O	1	Side and rear squeegees	Check for damage and wear	–	4
	O	2	Main brushes	Check for damage, wear, and debris	–	2
	O	3	Recovery tank	Clean tank and check cover seal	–	1
	O	4	Vacuum fan inlet filter	Clean	–	1
	O	5	Cylindrical brushes only: Debris tray	Clean	–	1
	O	12	Side brush (Option)	Check for damage, wear, debris	–	1
	O	12	Side brush squeegee (Option)	Check for damage and wear	–	1

Interval	Person Resp.	Key	Description	Procedure	Lubricant/ Fluid	No. of Service Points
Weekly	T	7	Battery cells	Check electrolyte level	DW	12
50 Hours	T	6	Squeegee caster wheel pivot points	Lubricate	SPL	2
	T	1	Side and rear squeegees	Check deflection and leveling	-	4
	O	2	Main brushes (cylindrical)	Rotate brushes from front to rear	-	2
	T	13	Scrub head skirts (disk)	Check skirts for damage and wear	-	2
100 Hours	T	7	Battery watering system (option)	Check hoses and connections for damage and wear	-	Multiple
200 Hours	T	7	Battery terminals and cables	Check and clean	-	12
	T	8	Cylindrical brush drive belts	Check for damage and wear	-	2
	T	13	Steering chain (T12XP Only)	Lubricate, check tension, and check for damage and wear.	GL	1
	T	9	Steering gear chain	Lubricate, check tension, and check for damage and wear.	GL	1
500 Hours	T	10	Vacuum fan motor(s)	Check motor brushes	-	1 (2)
	O	11	Tires	Check for damage and wear	-	3
1000 Hours	T	8	Main brush motors	Check motor brushes (Check every 100 hours after initial 1000 hour check)	-	2 (4)
	T	12	Side brush motor	Check motor brushes (Check every 100 hours after initial 1000 hour check)	-	1

LUBRICANT/FLUID

DW . . . Distilled water.

SPL . . . Special lubricant, Lubriplate EMB grease (Tennant part number 01433-1)

GL . . . SAE 90 weight gear lubricant

NOTE: More frequent maintenance intervals may be required in extremely dusty conditions.

MAINTENANCE

YELLOW TOUCH POINTS

This machine features easy to find yellow touch points for simple service items. No tools are required to perform these maintenance operations.



LUBRICATION

FOR SAFETY: Before leaving or servicing machine, stop on level surface, turn off machine, and remove key.

STEERING CHAIN (T12XP ONLY)

The steering chain is located on the steering column directly under the control panel. Check for damage or wear and lubricate the steering chain after every 200 hours.

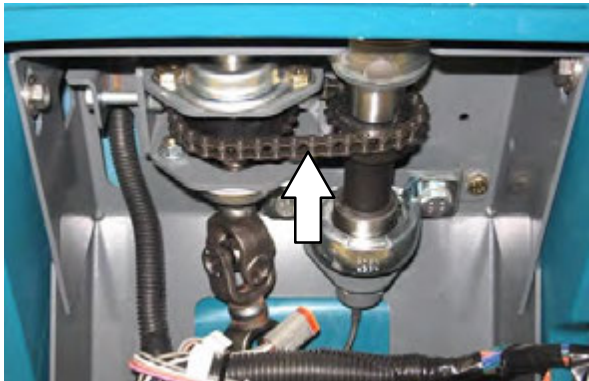

STEERING GEAR CHAIN

The steering gear chain is located directly above the front tire. Check for damage or wear and lubricate the steering gear chain after every 200 hours.

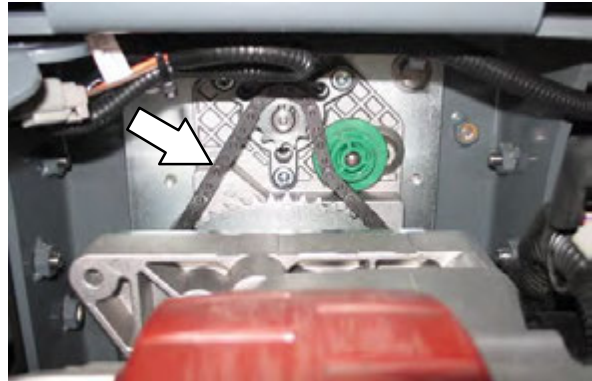

REAR SQUEEGEE CASTERS

Lubricate the rear squeegee caster pivot point on each squeegee caster after every 50 hours.



BATTERIES

FOR SAFETY: Before leaving or servicing machine, stop on level surface, turn off machine, set parking brake (if equipped), and remove key.

The lifetime of the batteries depends on their proper maintenance. To get the most life from the batteries;

FLOODED (WET) AND MAINTENANCE-FREE SEALED LEAD-ACID BATTERIES

- Do not charge the batteries more than once a day and only after running the machine for a minimum of 15 minutes.
- Do not leave the batteries partially discharged for long period of time.
- Only charge the batteries in a well-ventilated area to prevent gas build up. Charge batteries in areas with ambient temperatures 27°C (80°F) or less.
- Allow the charger to complete charging the batteries before re-using the machine.
- Maintain the proper electrolyte levels of flooded (wet) batteries by checking levels weekly.

CHECKING THE ELECTROLYTE LEVEL

The flooded (wet) lead-acid batteries require routine maintenance as described below. Check the battery electrolyte level weekly.

NOTE: Do Not check the electrolyte level if the machine is equipped with the battery watering system. Proceed to the BATTERY WATERING SYSTEM (OPTION).

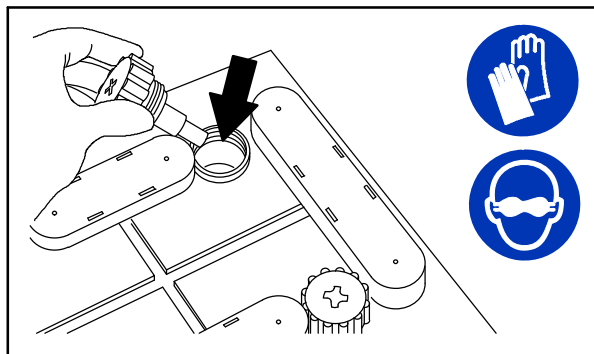

08247

FOR SAFETY: When servicing machine, keep all metal objects off batteries. Avoid contact with battery acid.

The level should be slightly above the battery plates as shown before charging. Add distilled water if low. **DO NOT OVERFILL.** The electrolyte will expand and may overflow when charging. After charging, distilled water can be added up to about 3 mm (0.12 in) below the sight tubes.

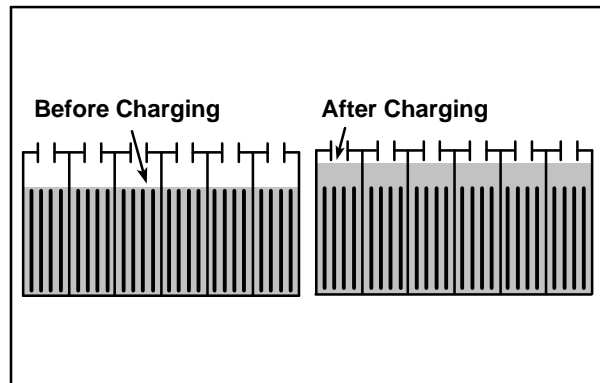

NOTE: Make sure the battery caps are in place while charging. There may be a sulfur smell after charging batteries. This is normal.

MAINTENANCE-FREE BATTERIES

Maintenance-free batteries do not require watering. Cleaning and other routine maintenance is still required.

CHECKING CONNECTIONS / CLEANING

After every 200 hours of use check for loose battery connections and clean the surface of the batteries, including terminals and cable clamps, with a strong solution of baking soda and water. Replace any worn or damaged wires. Do not remove battery caps when cleaning batteries.



LITHIUM-ION BATTERY PACK

The lithium-ion battery pack is a maintenance-free battery protected by a battery management system (BMS). To achieve the maximum battery life, carefully follow the instructions below:

- Carefully follow the Important Safety Instructions section in the manual when using the Lithium-ion Battery Model.
- Only use the lithium-ion battery charger supplied with machine.
- Charge battery pack in well-ventilated areas. For best charging performance, charge the battery pack in temperatures below 80°F/27°C and above 32°F/0°C. Battery pack may shut down and not take a charge in elevated or freezing temperatures.
- It is recommended to only recharge battery pack when discharge indicator level reaches the last bar. Do not store the machine for an extended period if battery is discharged to the last bar, the battery may further discharge to a level that is unrecoverable.
- When the machine shuts down due to a depleted battery pack, do not repeatedly cycle the key switch on and off. This may cause permanent battery pack damage. Recharge battery pack immediately to avoid damage.
- Allow charge cycle to completely charge battery pack.
- Opportunity charging (i.e. partial charge cycle of a half hour or more) is only recommended if discharge level is below 80%.
- Do not operate machine in temperatures above 110°F / 43°C or below -4°F / -20°C. Machine may shutdown if exceed these temperatures.
- When removing or replacing the lithium-ion battery pack, a specific lifting kit is recommended. It's important to use non-conductive lifting straps positioned at all four lift points with straps angled at 45° or greater when hoisting battery pack.
- Contact Tennant Service for lithium-ion battery service and replacement.

CHARGING THE BATTERIES (OFF-BOARD CHARGER)

IMPORTANT: Before charging, make sure that the charger setting is properly set for the battery type.

1. Drive the machine to a flat, dry surface in a well-ventilated area.
2. Stop the machine and turn off the machine power.

FOR SAFETY: Before leaving or servicing machine, stop on level surface, turn off machine, and remove key.

3. Lift the operator seat open and engage the seat support.

NOTE: If applicable, make sure the batteries have the proper electrolyte level before charging. See **CHECKING THE ELECTROLYTE LEVEL.**

4. Plug the charger AC power supply cord into a properly grounded outlet.
5. Plug the charger connector into the remote battery charge connector.

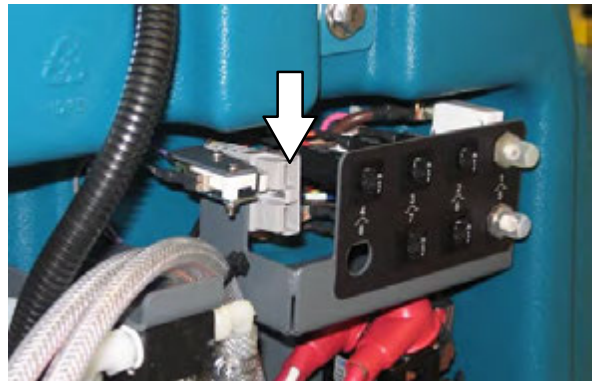

! WARNING: Lead-acid batteries emit hydrogen gas. Explosion or fire can result. Keep sparks and open flame away. Keep covers open when charging.

NOTE: If the charger "FAULT CODE" lights flash when the batteries are plugged into the charger, refer to the charger manufacturer manual for fault code definitions.

6. The Tennant charger will start automatically. When the batteries are fully charged, the Tennant charger will automatically turn off.
7. After the charger has turned off, unplug the charger connector from the remote battery charge connector.

ATTENTION: Do not disconnect the charger DC cord from the machine receptacle when the charger is operating. Arcing may result. If the charger must be interrupted during charging, disconnect the AC power supply cord first.

8. Close the operator seat.

CHARGING THE BATTERIES (ON-BOARD CHARGER)

IMPORTANT: Before charging, make sure that the charger setting is properly set for the battery type. See **ON-BOARD CHARGER SETTINGS**.

1. Drive the machine to a flat, dry surface in a well-ventilated area.
2. Stop the machine and turn off the machine power.

FOR SAFETY: Before leaving or servicing machine, stop on level surface, turn off machine, and remove key.

3. Lift the operator seat open and engage the seat support.

NOTE: If applicable, make sure the batteries have the proper electrolyte level before charging. See CHECKING THE ELECTROLYTE LEVEL.

4. Plug the on-board battery charger cord into a properly grounded wall outlet.



WARNING: Batteries emit hydrogen gas. Explosion or fire can result. Keep sparks and open flame away. Keep covers open when charging.

NOTE: The machine will not operate when charging.

5. The on-board charger will start charging the batteries. Once the charging cycle begins, the indicator lights will progress from red, yellow to green. When the green indicator light stays on, the charging cycle is done.



If the charger detects a problem, the charger will display an error code (See **ON-BOARD BATTERY CHARGER ERROR CODES**).

6. Unplug the on-board battery charger from the wall outlet and neatly stow the cord inside the battery compartment.

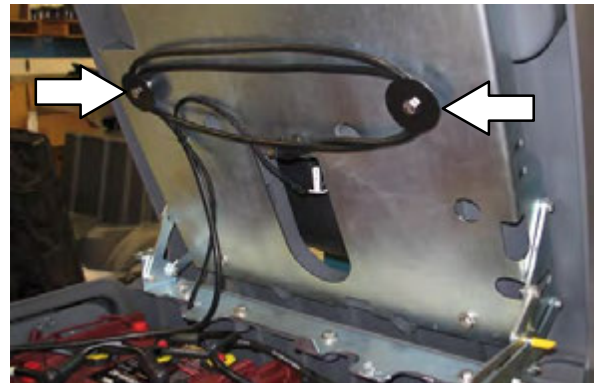

7. Close the operator seat.

MAINTENANCE

ON-BOARD BATTERY CHARGER ERROR CODES

Display Code	Fault	Solution
bat	Loose or damaged battery cable.	Check battery cable connection.
	Battery exceeded maximum voltage level.	No action necessary.
E01	Exceeded maximum battery voltage allowed. Interrupts charging cycle.	No action necessary.
E02	Safety thermostat exceeded maximum internal temperature. Interrupts charging cycle.	Ensure the charger vents are not obstructed. Clear obstructions.
E03	Exceeded maximum time for charging phase, leaving the batteries undercharged due to a sulfated or faulty battery. Interrupts charging cycle.	Repeat the charging cycle. If the error code E03 reappears check battery or replace it.
SCt	Safety timer exceeded maximum charging time. Interrupts charging cycle.	Replace battery.
Srt	Possible internal short circuit.	Contact a Tennant service representative.

ON-BOARD CHARGER SETTINGS

NOTE: The following instructions are intended for flooded (wet), maintenance-free lead-acid, and lithium-ion batteries.

If the machine is equipped with the on-board charger, the charger settings are properly set at the factory. If different batteries are put in the machine, the settings must be changed to match the new battery type before charging. Failure to properly set the charger will result in battery damage.

Refer to the battery label for the battery type. Contact the battery manufacturer if battery is not labeled.

To verify the setting of the charger, connect the charger cord into an electrical outlet. The charger will display a sequence of the following codes (three-digits + the code) when the cord is connected:

- A = Charging current
- U = Battery Voltage
- h = Charging time
- C = Charging ampere-hours [Ah]
- E = Energy used [Kwh]
- "GEL", "Acid" or "LITH" = Battery type for which the charger is currently set. Before charging make sure battery type matches the display: GEL=Sealed, Acid=WET (lead acid), or LITH= Lithium-Ion.

Press the arrow button to review the codes. Refer to the battery type code to determine the charger battery type setting.



To change the setting, unplug the charger and peel up the corner of the display label to access the switches. The charger cord must be unplugged when resetting.



Adjust the switches to the correct setting for the batteries.

Lead Acid 240Ah:

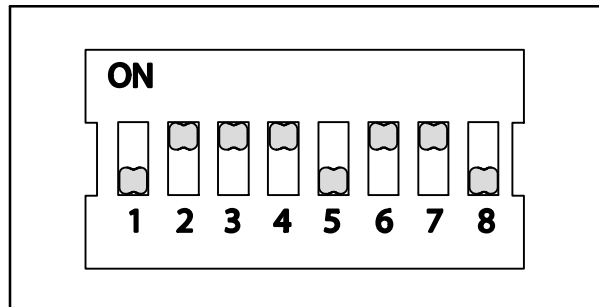

Lead Acid 360Ah:

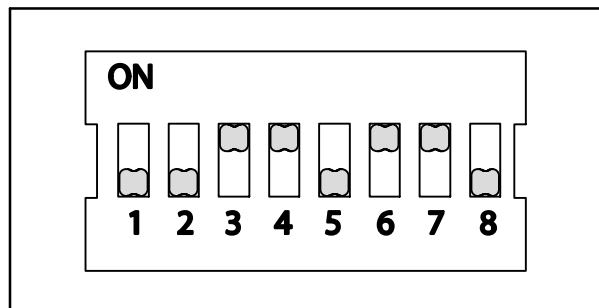

Gel:

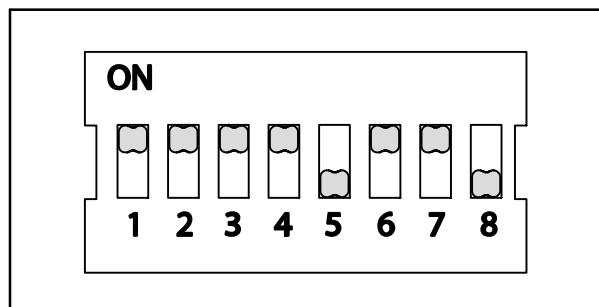

MAINTENANCE

Lithium-Ion:

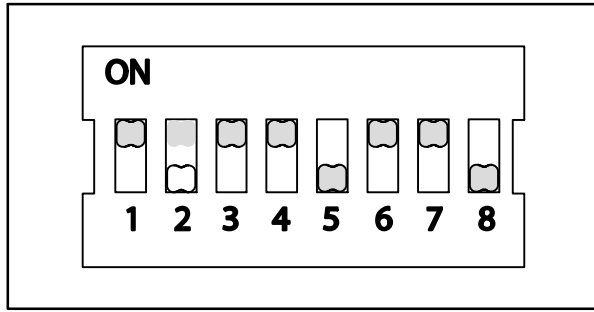

CHANGING THE ON-BOARD BATTERY CHARGER FUSE

FOR SAFETY: Before leaving or servicing machine, stop on level surface, turn off machine, and remove key.

A 15 Amp fuse protects the on-board charger. Follow the instructions below to replace a blown fuse. Never substitute a higher Amp rated fuse than specified.

1. Lift the operator seat open and engage the seat support.
2. Unplug the charger AC power supply cord from the wall outlet.



WARNING: Electrical Hazard. Unplug charger before servicing machine.

3. Disconnect the battery cables from the batteries.

FOR SAFETY: When servicing machine, disconnect battery connection before working on machine.

4. Remove the hardware holding the side panel to the machine and remove the side panel from the machine.

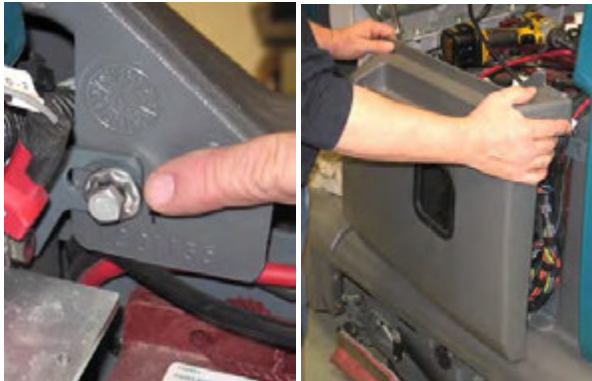

5. Remove the hardware holding the on-board battery charger onto the machine

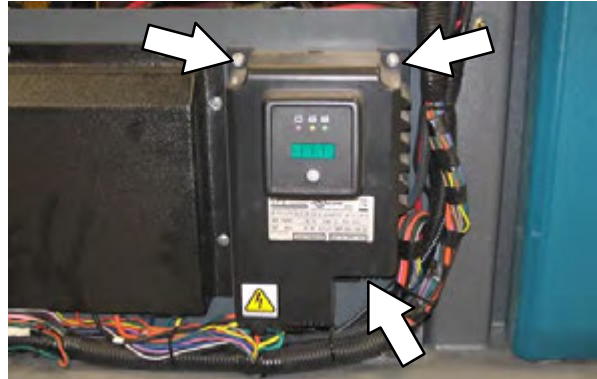

6. Carefully pull the on-board charger out to access the fuse.

7. Remove the fuse cap and replace the fuse.

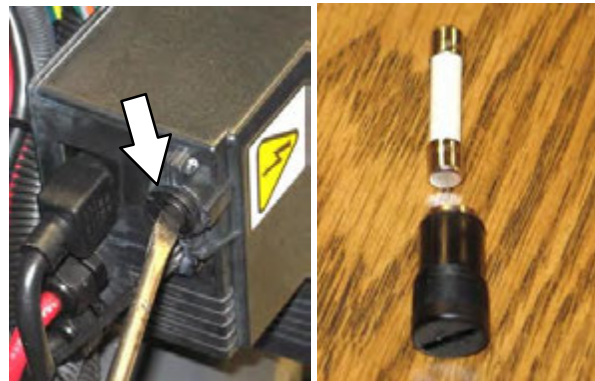

8. Reinstall the on-board battery charger and side panel onto the machine.

MAINTENANCE

FLOW-RITE™ BATTERY WATERING SYSTEM (OPTION)

The optional Flow-Rite battery watering system provides a safe and easy way to maintain the proper electrolyte levels in the batteries.

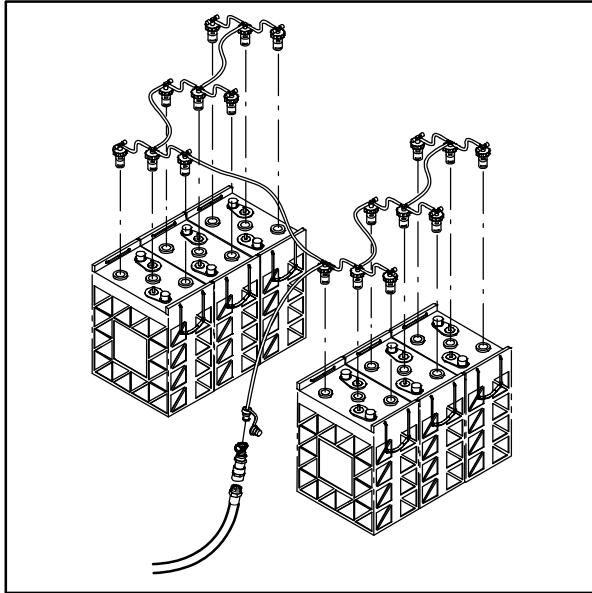

Check the battery watering system hoses and connections for damage or wear after every 100 hours.

FOR SAFETY: Before leaving or servicing machine, stop on level surface, turn off machine, and remove key.

1. Lift the operator seat open and engage the seat support.
2. Fully charge batteries prior to using the battery watering system. Do not add water to batteries before charging, the electrolyte level will expand and may overflow when charging. See *CHARGING THE BATTERIES (OFF-BOARD CHARGER)* or *CHARGING THE BATTERIES (ON-BOARD CHARGER)*.

3. Connect the water supply hose to the fill regulator.

NOTE: Water quality is important to maintain the life of the battery. Always use water that meets battery manufacturer requirements.



NOTE: The water supply to the battery water system must always be 7.57 LPM (2 GPM) or more. Use the purger to confirm the water supply pressure. Refer to Flow-Rite Operator Manual for additional information.



4. Remove the dust cover from the battery fill tube and connect the fill regulator.



5. Turn on the water supply. The red balls inside the flow indicator will spin. The red balls stop spinning when the batteries are full.

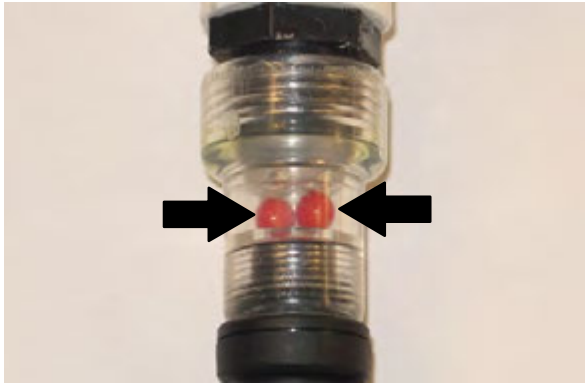

6. Disconnect the battery fill tube from the fill regulator.
7. Turn off the water supply.
8. After adding water, replace the dust cap on the battery fill hose and return the fill regulator to the storage location for future use.

MAINTENANCE

HYDROLINK® BATTERY WATERING SYSTEM (OPTION)

The following instructions are for models equipped with the HydroLINK battery watering system option.

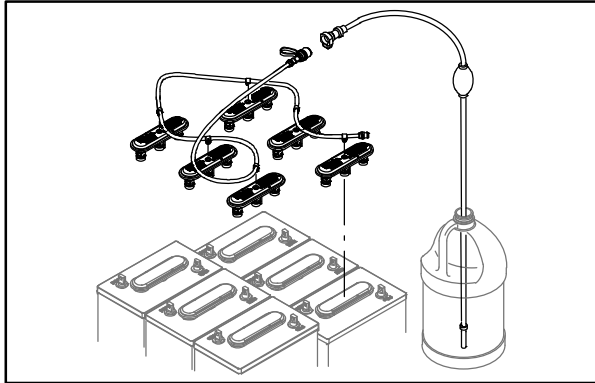

The optional HydroLINK battery watering system provides a safe and easy way to maintain the proper electrolyte levels in your batteries. It is designed exclusively for Trojan® wet/lead-acid batteries.

Check the battery watering system hoses and connections for damage or wear after every 100 hours.

FOR SAFETY: Before leaving or servicing machine, stop on level surface, turn off machine, and remove key.

1. Lift the operator seat open and engage the seat support.
2. Fully charge batteries prior to using the battery watering system. Do not add water to batteries before charging, the electrolyte level will expand and may overflow when charging. See *CHARGING THE BATTERIES (OFF-BOARD CHARGER)* or *CHARGING THE BATTERIES (ON-BOARD CHARGER)*.

3. After charging batteries, check the battery electrolyte level indicators located on the battery covers. If the level indicator is white add water as described in the following instructions. If the level indicators are black the electrolyte is at the correct level, no water is required.

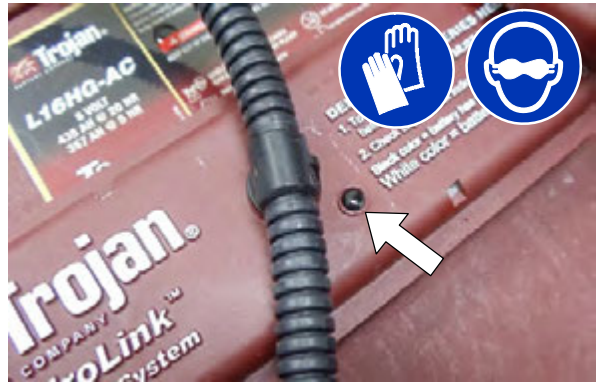

4. Locate the battery fill hose coupler inside the battery compartment. Remove the dust cap and connect the hand pump hose.

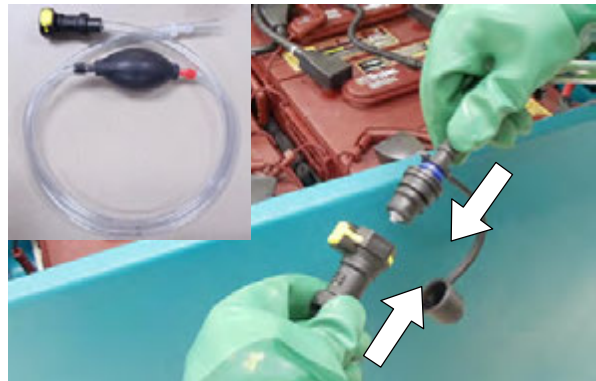

5. Submerge the other end of the hand pump hose into a bottle of distilled water.



6. Squeeze the bulb on the hand pump hose until firm. The level indicators will turn black when full.

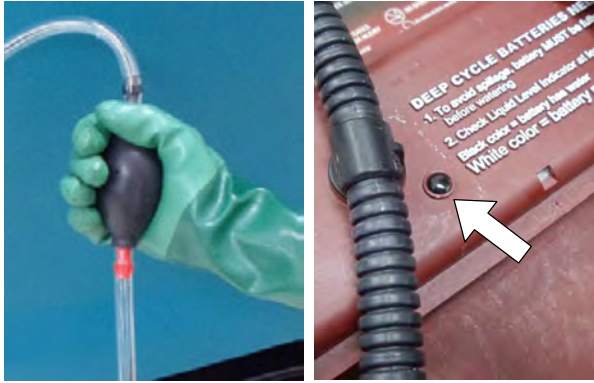

7. After adding water, replace the dust cap on the battery fill hose and store the hand pump hose inside the machine's battery compartment for future use.

MAINTENANCE

MANUAL BATTERY WATERING SYSTEM (Trojan® Battery OPTION)

The following instructions are for models equipped with the manual battery watering system option.

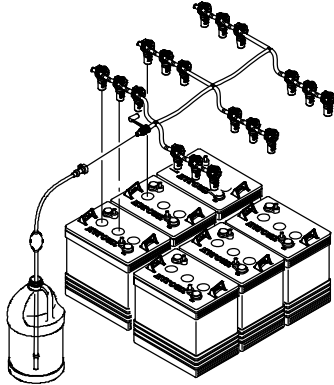

The optional manual battery watering system provides a safe and easy way to maintain the proper electrolyte levels in your batteries. It is designed exclusively for Trojan flooded (wet) lead acid batteries.

FOR SAFETY: When servicing machine, wear personal protection equipment as needed. Avoid contact with battery acid..

Before using the battery watering system check hoses and connections for damage or wear.

1. Fully charge batteries prior to using the battery watering system. Do not add water to batteries before charging, the electrolyte level will expand and may overflow when charging
2. After charging batteries, check the battery electrolyte level indicators located on the battery covers.



3. If the level indicator has a low white float add water as described in the following instructions.

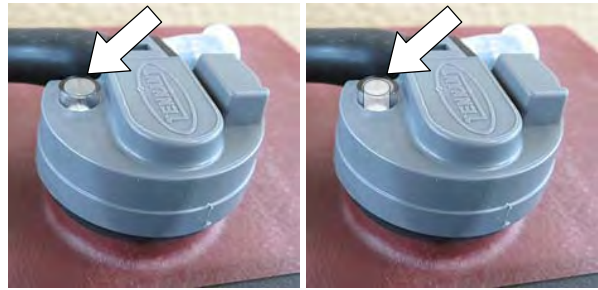

Low Float = Add Water High Float = Full

4. Locate the battery fill hose coupler inside the battery compartment. Remove the dust cap and connect the hand pump hose.

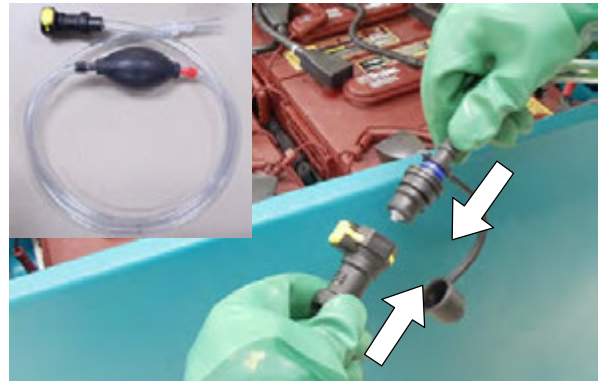

5. Submerge the other end of the hand pump hose into a bottle of distilled water.



6. Squeeze the bulb on the hand pump hose until firm. The level indicators will turn black when full.

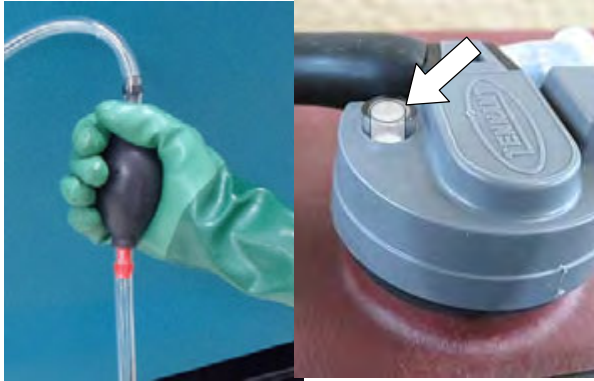

High Float = Full

7. After adding water, replace the dust cap on the battery fill hose and store the hand pump hose inside the machine's battery compartment for future use.

MAINTENANCE

CIRCUIT BREAKERS

Circuit breakers are resettable electrical circuit protection devices designed to stop the flow of current in the event of a circuit overload. Once a circuit breaker is tripped, reset it manually by pressing the reset button after the breaker has cooled down.

Circuit breakers 1 through 8 are located behind the operator seat.

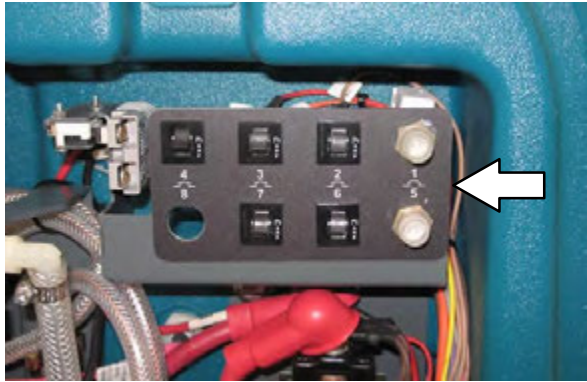

Circuit breakers 9 through 16 are located behind the steering shroud access panel.



Circuit breaker 17 is located inside the optional light assembly mounted on top of the recovery tank.

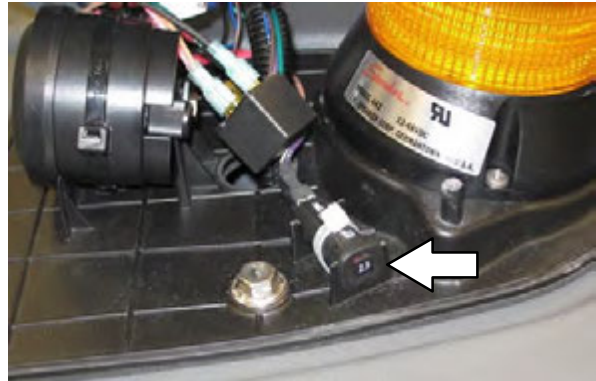

If the overload that caused the circuit breaker to trip is still present, the circuit breaker will continue to stop current flow until the problem is corrected.

The chart below shows the circuit breakers and the electrical components they protect.

Circuit Breaker	Rating	Circuit Protected
CB1	80 A	Propel system
CB2	2 A	Telemetry system
CB3	2.5 A	Key switch – Start
CB4	2.5 A	Scrub system
CB5	60 A	Scrub module
CB6	2.5 A	ec-H2O module (Option)
CB7	2.5 A	ec-H2O pump (Option)
CB8	2.5 A	Not used
CB9	20 A	Side brush module (Option)
CB10	2.5 A	Side brush system (Option)
CB11	15 A	Spray nozzle pump (Option)
CB12	15 A	Lights (Option)
CB13	2.5 A	Headlight / Tail lights (Option)
CB14	2.5 A	Overhead guard warning light (Option)
CB15	2.5 A	Warning lights (Option)
CB16	N/A	Not used
CB17	2.5A	Reverse alarm light (Option)

ELECTRIC MOTORS

Inspect the carbon brushes on the vacuum fan motor after every 500 hours of operation. Inspect the carbon brushes on the main brush motors and side brush motor after the first 1000 hours of operation and every 100 hours after the initial check. Refer to the table below for carbon brush inspection intervals.

Carbon Brush Inspection	Hours
Main Brush Motors	1000*
Side Brush Motor (Option)	1000*
Vacuum Motor	500

**Inspect carbon brushes every 100 hours after the initial 1000 hour change.*

MAINTENANCE

SCRUB BRUSHES

The machine can be equipped with either *disk* or *cylindrical* scrub brushes. Check scrub brushes daily for wire or string tangled around the brush or brush drive hub. Also check brushes or pads for damage and wear.

DISK BRUSHES AND PADS

Replace the pads when they no longer clean effectively. Replace the brushes when they no longer clean effectively or when the bristles are worn to the yellow indicator.

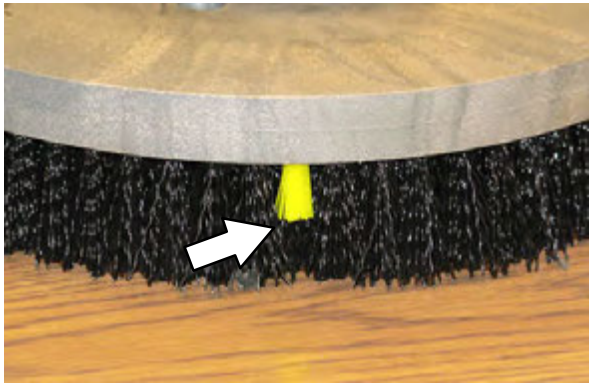

Cleaning pads must be placed on pad drivers before they are ready to use. The cleaning pad is held in place with a center disk. Both sides of the pad can be used for scrubbing. Turn the pad over to use the other side.

Cleaning pads need to be cleaned immediately after use with soap and water. Do not wash the pads with a pressure washer. Hang pads, or lay pads flat to dry.

NOTE: Always replace brushes and pads in sets. Otherwise one brush or pad will be more aggressive than the other.

REPLACING DISK BRUSHES OR PAD DRIVERS

1. Raise the scrub head.
2. Turn off the machine.

FOR SAFETY: Before leaving or servicing machine, stop on level surface, turn off machine, and remove key.

3. Open the main brush access door and side squeegee support door.



4. Turn the brush until the spring handles are visible.

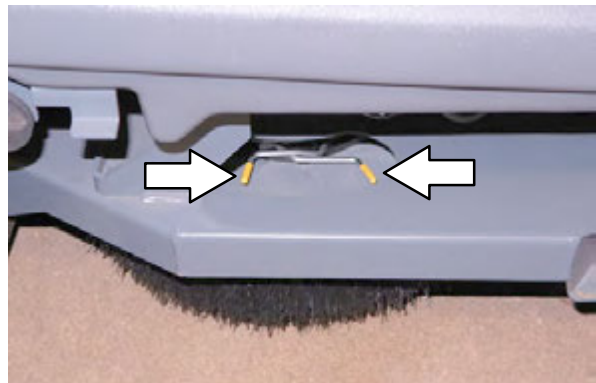

5. Squeeze the spring handles and let the brush drop to the floor. Remove the brush from under the scrub head.

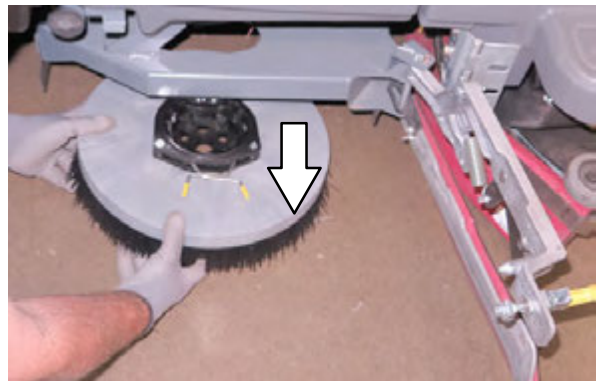

- Set the brush spring open on the new brush to make installation easier.



- Push the new brush under the scrub head, align the brush drive socket with the brush drive hub, and lift the brush up onto the brush drive hub until the brush locks onto the hub.

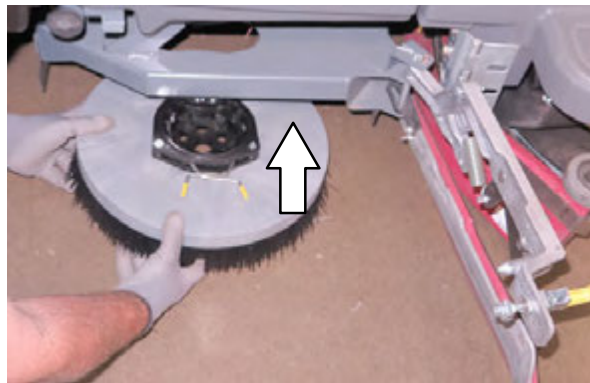

- Ensure the brush is securely mounted on the brush drive hub.
- Close and secure the squeegee support door and close the main brush access door.
- Repeat procedure for the other brush.

REPLACING DISK SCRUB PADS

- Remove the pad driver from the machine.
- Squeeze the spring clip together and remove the center disk from the pad driver.



- Remove the scrub pad from the pad driver.



- Flip or replace the scrub pad. Center the scrub pad on the pad driver and reinstall the center disk to secure the pad in place on the pad driver.
- Reinstall the pad driver onto the machine.

MAINTENANCE

CYLINDRICAL BRUSHES

Rotate the brushes from front-to-rear after every 50 hours of operation.

Replace the brushes when they no longer clean effectively.

NOTE: Replace worn brushes in pairs. Scrubbing with brushes of unequal bristle length will result in diminished scrubbing performance.

REPLACING CYLINDRICAL SCRUB BRUSHES

FOR SAFETY: Before leaving or servicing machine, stop on level surface, turn off machine, and remove key.

1. Open the main brush access door and side squeegee support door.



2. Remove the idler plate from the scrub head.



3. Remove the brush from the scrub head



4. Position the brush with the *double row end* towards the scrub head opening. Guide the new brush onto the drive hub.

5. If rotating the brushes, always rotate the front with the back so that they wear evenly. They may be rotated end for end as well.

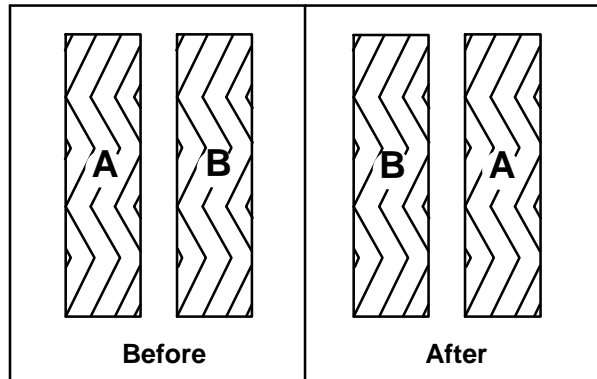

6. Reinstall the idler plate onto the scrub head.

NOTE: Do not switch the left or right idler plates or the brushes will need to be readjusted by trained personnel.

7. Close and secure the squeegee support door and close the main brush access door.
8. Repeat for the brush on the other side of the scrub head.

SIDE BRUSH (OPTION)

FOR SAFETY: Before leaving or servicing machine, stop on level surface, turn off machine, and remove key.

Check the side brush daily for wear or damage. Remove any tangled string or wire from the side brush or side brush drive hub.

REPLACING THE SIDE BRUSH

Replace the pads when they no longer clean effectively. Replace the brushes when they no longer clean effectively or when the bristles are worn to the yellow indicator.

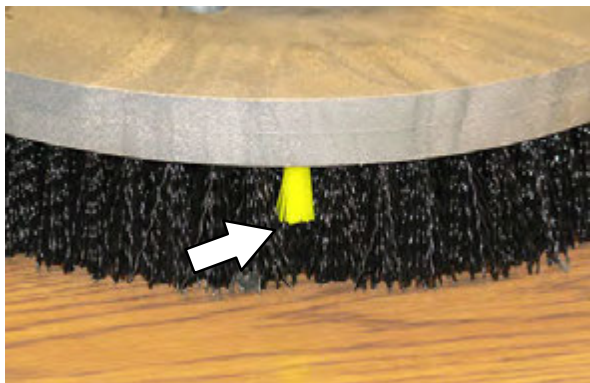

1. Loosen the side brush squeegee assembly handle and remove the squeegee assembly from the machine.



2. Squeeze the spring handles and let the side brush drop to the floor.



3. Remove the side brush from under the side brush assembly.



4. Set the brush spring open on the new brush to make installation easier.

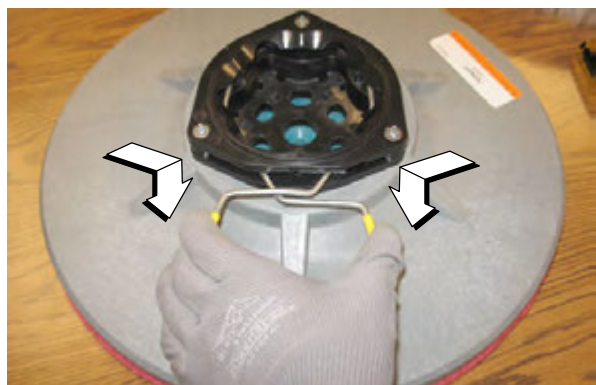

5. Place the new side brush underneath the side brush assembly and lift the side brush up onto the side brush hub until the brush locks onto the hub.
6. Reinstall the side brush squeegee assembly onto the side brush assembly.

SQUEEGEE BLADES

Check the squeegee blades for damage and wear daily. When the blades become worn, rotate the blades end-for-end or top-to-bottom to a new wiping edge. Replace blades when all edges are worn.

Check the deflection of the squeegee blades daily or when scrubbing a different type of surface. Check the leveling of the rear squeegee every 50 hours of operation.

REPLACING (OR ROTATING) THE REAR SQUEEGEE BLADES

1. Lower the scrub head.

FOR SAFETY: Before leaving or servicing machine, stop on level surface, turn off machine, and remove key.

2. Disconnect the vacuum hose from the rear squeegee assembly.



3. Loosen both squeegee mounting handles.

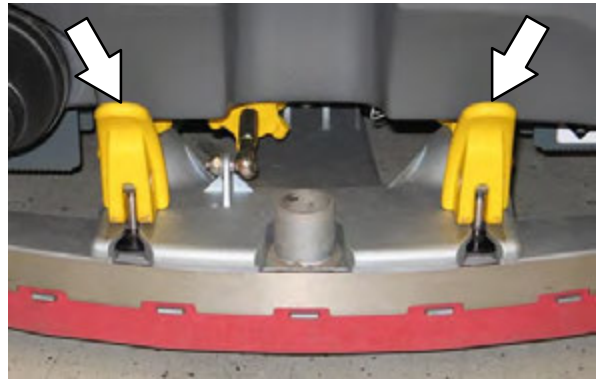

4. Pull the rear squeegee assembly from the machine.



5. Loosen the retainer latch and remove the retainer from the squeegee assembly.



6. Remove the squeegee from the squeegee assembly.



7. Slide both retainers out away from the squeegee assembly.

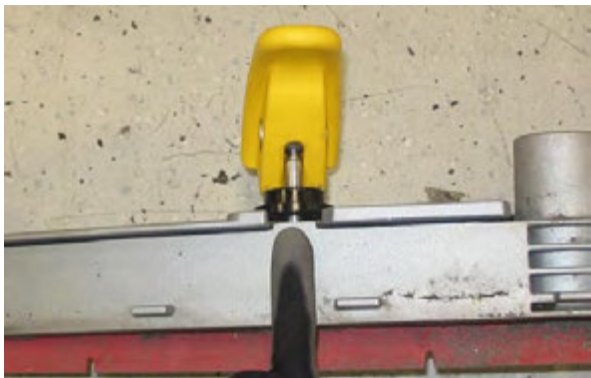

8. Remove the inner frame from the outer frame.



9. Remove the squeegee from the outer frame.



10. Install the rotated or new squeegee blade into the outer frame. Be sure the squeegee is completely slid down onto each tab on the outer frame.

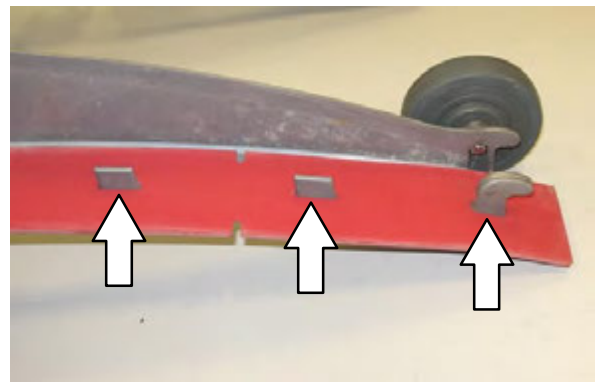

MAINTENANCE

11. Install the inner frame over the squeegee and onto the outer frame. Be sure the inner frame is tight against the top of the outer frame.

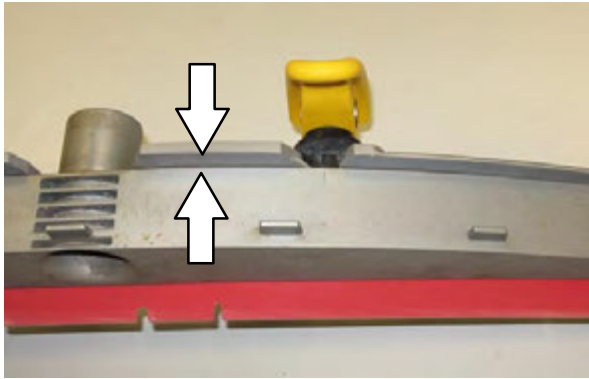

12. Slide both retainers into the squeegee assembly.



13. Place the rotated or new squeegee blade onto the inner frame. Be sure the squeegee is securely attached on each tab on the inner frame.



14. Insert the hinge end of the retainer into the hooks in the inner frame.

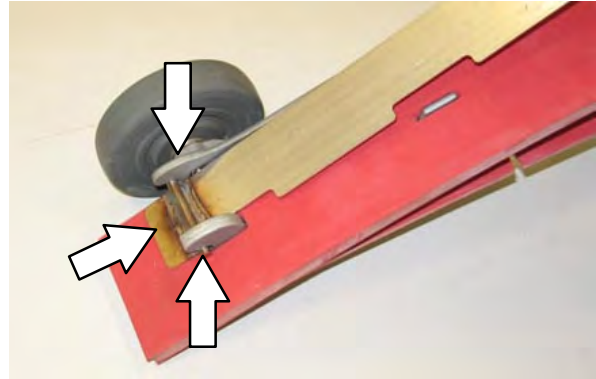

15. Install the retainer along the rest of the squeegee assembly and fasten the latch onto the other end of the squeegee assembly.

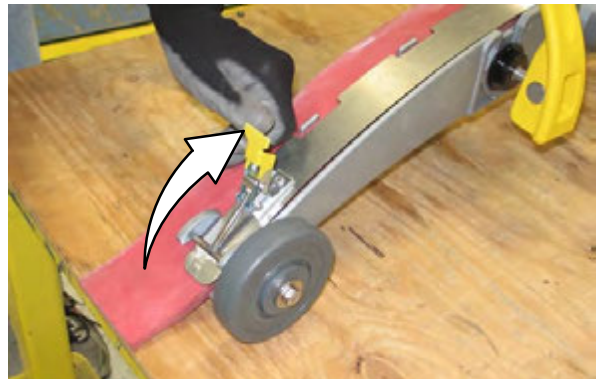

LEVELING THE REAR SQUEEGEE

Leveling the squeegee ensures the entire length of the squeegee blade is in even contact with the surface being scrubbed. Perform this adjustment on an even and level floor.

1. Lower the squeegee and drive the machine several meters (feet) forward and slowly bring the machine to a stop.

FOR SAFETY: Before leaving or servicing machine, stop on level surface, turn off machine, and remove key.

2. Check the squeegee deflection over the full length of the squeegee blade.
3. If the deflection is not the same over the full length of the blade, use the tilt adjust knob to make adjustments.

DO NOT disconnect the vacuum hose from the squeegee frame when leveling squeegee.

4. To adjust the squeegee leveling, loosen the tilt lock knob.

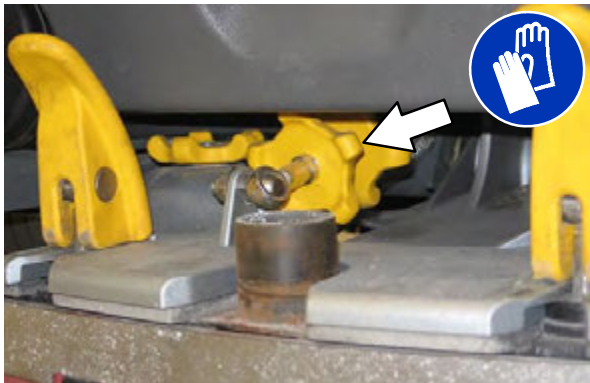

5. Turn the squeegee tilt adjust knob counter-clockwise to decrease the deflection at the ends of the squeegee blade.

Turn the squeegee tilt adjust knob clockwise to increase the deflection at the ends of the squeegee blade.



6. Tighten the tilt lock knob.
7. Drive the machine forward with the squeegee down to recheck the squeegee blade deflection if adjustments were made.
8. Readjust the squeegee blade deflection if necessary.

MAINTENANCE

ADJUSTING THE REAR SQUEEGEE BLADE DEFLECTION

Deflection is the amount of curl the overall squeegee blade has when the machine moves forward. The best deflection is when the squeegee wipes the floor dry with a minimal amount of deflection.

NOTE: Make sure the squeegee is level before adjusting the deflection. See LEVELING THE REAR SQUEEGEE.

1. Lower the squeegee and drive the machine several meters (feet) forward and slowly bring the machine to a stop.

FOR SAFETY: Before leaving or servicing machine, stop on level surface, turn off machine, and remove key.

2. Look at the amount of deflection or “curl” of the squeegee blade. The correct amount of deflection is 12 mm (0.50 in) for scrubbing smooth floors and 15 mm (0.62 in) for rough floors.

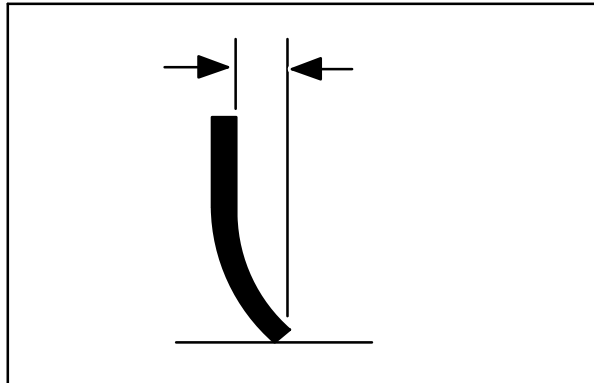

3. To adjust the overall squeegee blade deflection, loosen the lock knob.



4. Turn the adjustment knobs counterclockwise to increase deflection or clockwise to decrease deflection.

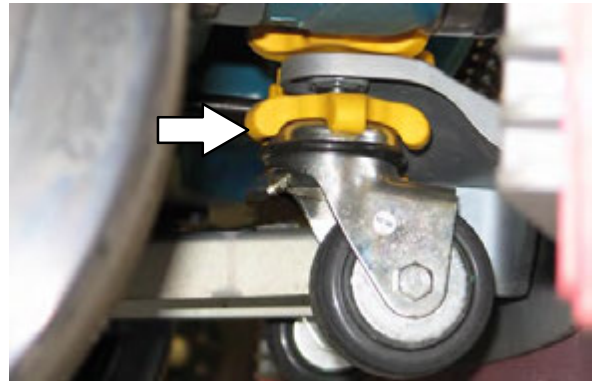

5. Retighten the lock knob.
6. Drive the machine forward again to recheck the squeegee blade deflection.
7. Readjust the squeegee blade deflection if necessary.

REPLACING OR ROTATING THE SIDE SQUEEGEE BLADES

1. If necessary, raise the scrub head.

FOR SAFETY: Before leaving or servicing machine, stop on level surface, turn off machine, and remove key.

2. Open the main brush access door and side squeegee support door.



3. Unhook the retaining band latch from the side squeegee assembly.

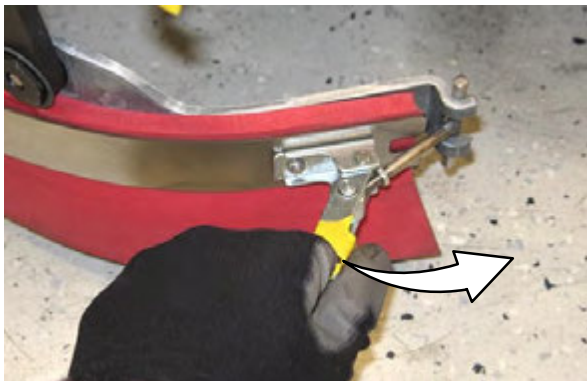

4. Remove the retaining band from the side squeegee assembly.



5. Remove the squeegee blade from the side squeegee assembly.



6. Install the rotated or new rear squeegee blade onto the side squeegee assembly.

7. Hook the retaining band onto the retaining band retainer tab on the side squeegee assembly.

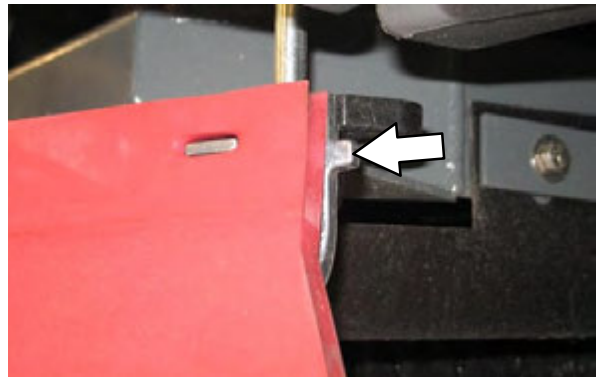

8. Fasten the retaining band latch onto the side squeegee assembly.



9. Close and secure the squeegee support door and close the main brush access door.

10. Repeat for the side squeegee on the other side of the scrub head.

MAINTENANCE

REPLACING OR ROTATING THE SIDE BRUSH SQUEEGEE BLADES (OPTION)

FOR SAFETY: Before leaving or servicing machine, stop on level surface, turn off machine, and remove key.

Check the side brush squeegee blade for damage and wear daily. Replace or rotate the blade if the leading edge is torn or worn half-way through the thickness of the blade.

1. Loosen the side brush squeegee assembly handle and remove the squeegee assembly from the machine.



2. Loosen the retaining band latch.



3. Remove the retaining band, squeegee blades, and spacer from the squeegee frame.



NOTE: Observe which squeegee slots were installed on the squeegee frame before removing the squeegee.



NOTE: The squeegee blade(s) have two sets of slots for adjusting the squeegee blade deflection. Install / reinstall squeegees so the deflection is approximately 12 mm (0.50 in) for smooth floors and 15 mm (0.62 in) for rough floors.

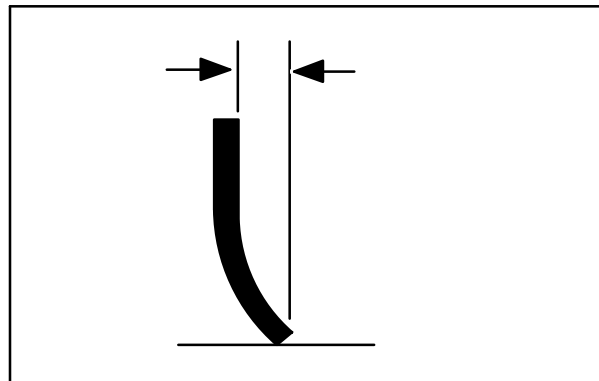

4. Install the rotated / new squeegee blades, spacer, and retaining band onto the side brush assembly.



5. Fasten the side brush retaining band latch.



6. Reinstall the side brush squeegee assembly onto the side brush assembly.

MAINTENANCE

SKIRTS AND SEALS

FOR SAFETY: Before leaving or servicing machine, stop on level surface, turn off machine, and remove key.

RECOVERY TANK SEAL

Check the recovery tank cover seal for damage and wear daily.

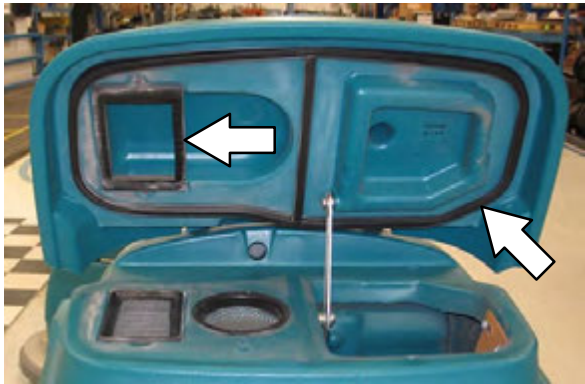

SCRUB HEAD SKIRTS (DISK SCRUB HEADS ONLY)

Check the scrub head skirts for damage and wear after every 50 hours of operation.

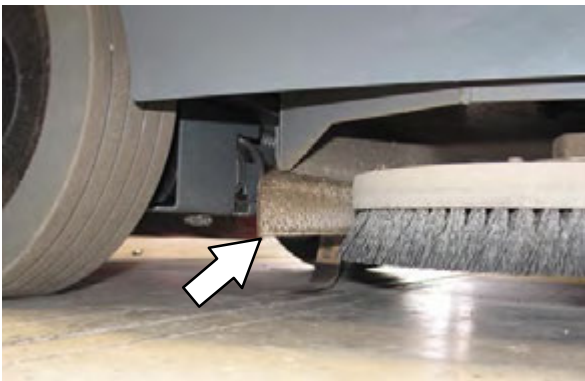
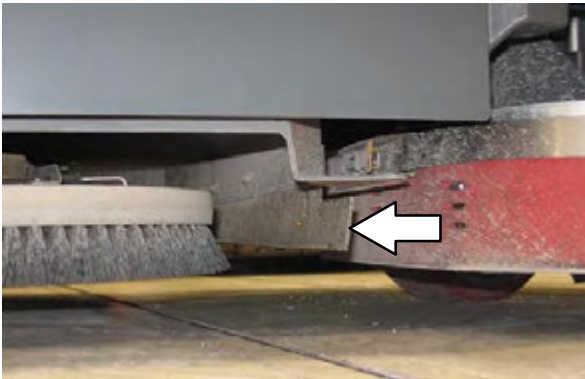

BELTS

CYLINDRICAL BRUSH DRIVE BELTS

FOR SAFETY: Before leaving or servicing machine, stop on level surface, turn off machine, and remove key.

The brush drive belts are located on the cylindrical brush scrub head. Check the belts for damage and wear after every 200 hours of operation.

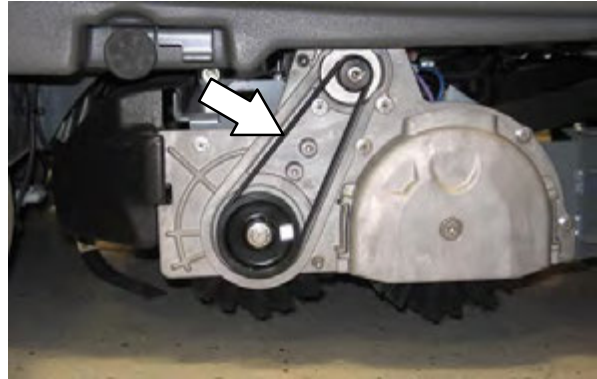

TIRES

FOR SAFETY: Before leaving or servicing machine, stop on level surface, turn off machine, and remove key.

The machine has three solid rubber tires: one in front, and two in the rear of the machine. Check tires for damage and wear after every 500 hours of operation.

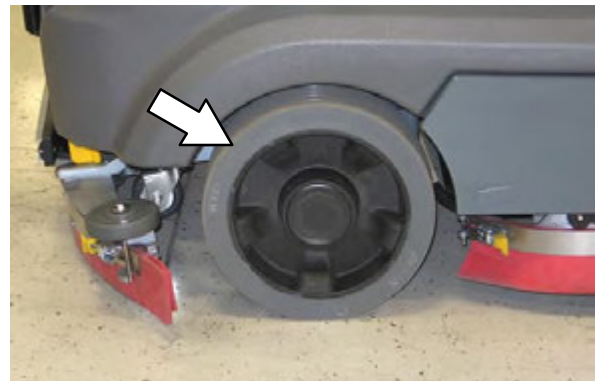

PUSHING, TOWING, AND TRANSPORTING THE MACHINE

PUSHING OR TOWING THE MACHINE

If the machine becomes disabled, it can be pushed or towed from the front or rear.

The parking brake must be disabled before towing or pushing the machine. To disable the brake, insert the tip of a small screw driver between the electronic brake lever and the hub. The machine can move freely when the parking brake is disabled.



Only push or tow the machine for a *very short distance* and do not exceed 3.2 kp/h (2 mph). It is NOT intended to be pushed or towed for a long distance or at a high speed.

ATTENTION! Do not push or tow machine for a long distance or damage may occur to the propelling system.

Immediately after pushing the machine, remove the screw driver from between the electronic brake lever and the hub. NEVER operate the machine with the parking brake disabled.

FOR SAFETY: Do not operate machine with brake disabled.

TRANSPORTING THE MACHINE

FOR SAFETY: When transporting Lithium-ion Battery Model, contact Tennant or your local regulatory authorities for proper transporting instructions.

1. Raise the squeegee, scrub head, and brushes.

FOR SAFETY: When loading/unloading machine onto/off truck or trailer, drain tanks before loading machine.

2. Position the machine at the loading edge of the truck or trailer.
3. If the loading surface is not horizontal or is higher than 380 mm (15 in) from the ground, use a winch to load machine.

If the loading surface is horizontal AND is 380 mm (15 in) or less from the ground, the machine may be driven onto the truck or trailer.

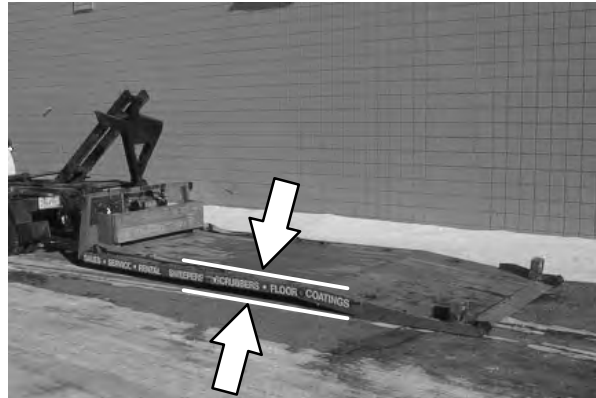

FOR SAFETY: When loading machine onto truck or trailer, use winch. Do not drive the machine onto the truck or trailer unless the loading surface is horizontal AND is 380 mm (15 in) or less from the ground.

4. To winch the machine onto the truck or trailer, attach the winching chains to the stabilizer legs.

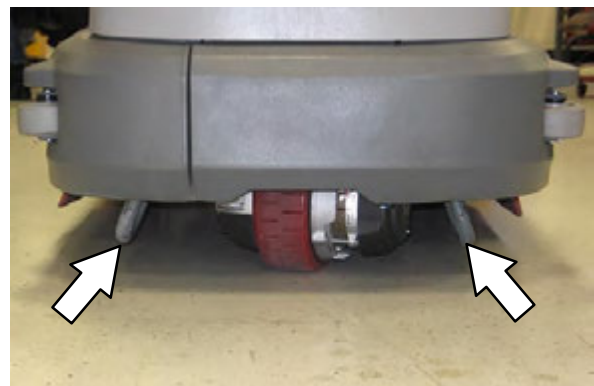

5. Position the machine as close to the front of the trailer or truck as possible. If the machine starts to veer off the center line of the truck or trailer, stop and turn the steering wheel to center the machine.

MAINTENANCE

6. Place a block behind each wheel to prevent the machine from rolling.
7. Lower the scrub head and turn off machine.

FOR SAFETY: When loading/unloading machine onto/off truck or trailer, lower scrub head and squeegee before tying down machine.

8. Connect the tie-down straps to the right and left stabilizer bars in front of the machine and the holes in the rear jacking brackets at the rear of the machine.

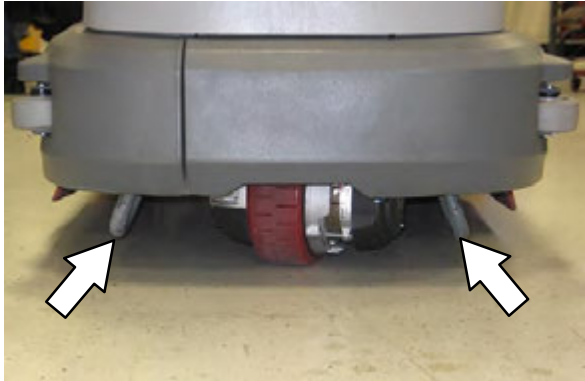

9. If the loading surface is not horizontal or is higher than 380 mm (15 in) from the ground, use a winch to unload machine.

If the loading surface is horizontal AND is 380 mm (15 in) or less from the ground, the machine may be driven off the truck or trailer.

FOR SAFETY: When unloading machine off truck or trailer, use winch. Do not drive the machine off the truck or trailer unless the loading surface is horizontal AND 380 mm (15 in) or less from the ground.

MACHINE JACKING

FOR SAFETY: Before leaving or servicing machine, stop on level surface, turn off machine, and remove key.

Empty the recovery and solution tanks before jacking the machine.

Jacking point location at the front of all machines.

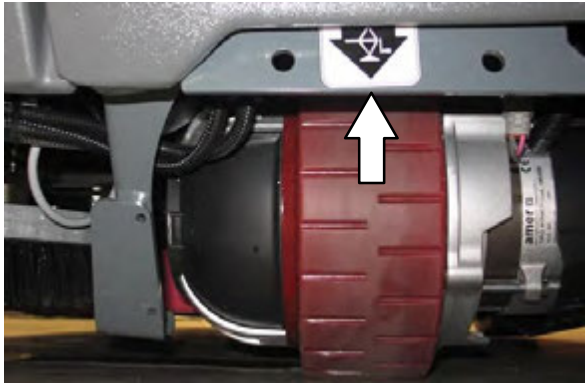

Jacking point location at the rear of machines not equipped with the optional rear squeegee protector.



Jacking point location at the rear of machines equipped with the optional rear squeegee protector.

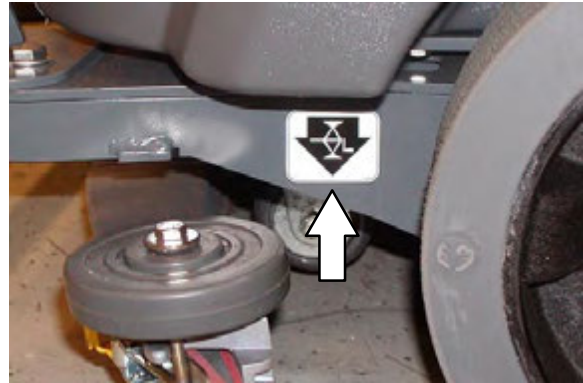

FOR SAFETY: When servicing machine, block machine tires before jacking machine up. Use a hoist or jack that will support the weight of the machine. Jack machine up at designated locations only. Support machine with jack stands.

MAINTENANCE

ec-H2O MODULE FLUSH PROCEDURE

This procedure is only required when an alarm sounds and the ec-H2O system indicator light begins to blink.

FOR SAFETY: Before leaving or servicing machine, stop on level surface and turn off machine.

1. Lift the operator seat open and engage the seat support.
2. Remove the drain hose from the ec-H2O compartment.



3. Press the connector button to disconnect the outlet hose from the ec-H2O manifold.

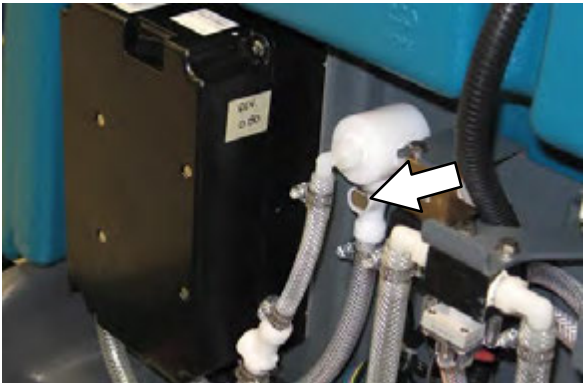

4. Connect the drain hose to the ec-H2O manifold hose disconnected from the ec-H2O manifold in the previous step.



5. Place the drain hose into a empty container.



6. Pour 2 gallons (7.6 liters) of white or rice vinegar into the solution tank.

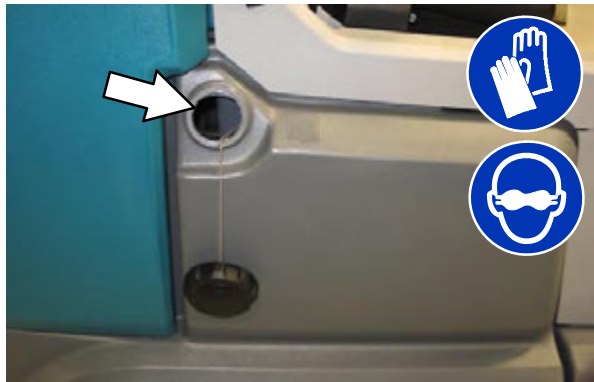

7. Start the machine.
8. Press and release the *ec-H2O* module flush switch to start the flush cycle.

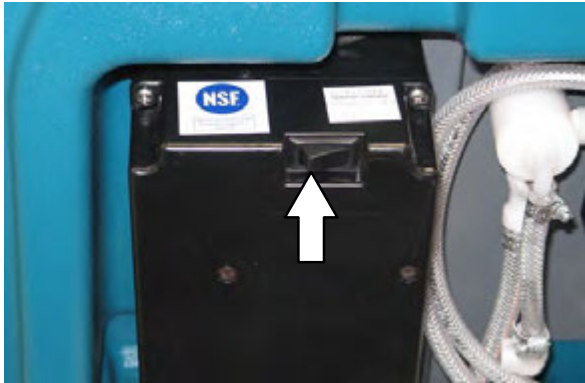

NOTE: The module will automatically shut off when the flush cycle is complete (approximately 7 minutes). The module must run the full 7-minute cycle in order to reset the system indicator light and alarm.

9. Pour 2 gallons (7.6 liters) of cool clean water into the solution tank.
10. Press and release the flush switch to rinse any remaining vinegar from the module. After 1–2 minutes, press the flush switch to turn off the module.
11. Disconnect the drain hose from the *ec-H2O* manifold hose.
12. Reconnect the outlet hose to the the scrub head to the *ec-H2O* manifold.
13. Place the drain hose back into the *ec-H2O* compartment.
14. Close the operator seat.

MAINTENANCE

STORAGE INFORMATION

The following steps should be taken when storing the machine for extended periods of time.

1. Charge the batteries before storing machine to prolong the life of the batteries. Recharge lead–acid batteries once a month. Recharge Lithium–ion Battery Pack once a year.
2. Disconnect batteries before storing.
3. Thoroughly drain and rinse the solution and recovery tanks.
4. Store the machine in a dry area with the squeegee and scrub head in the up position.

ATTENTION: Do not expose machine to rain, store indoors.

5. Open the recovery tank cover to promote air circulation.
6. If storing machine in freezing temperatures, proceed to *FREEZE PROTECTION*.

NOTE: To prevent potential machine damage store machine in a rodent and insect free environment.

FREEZE PROTECTION

FOR SAFETY: Before leaving or servicing machine, stop on level surface and turn off machine.

FOR SAFETY: When storing Lithium–ion Battery Model, do not expose battery to temperatures below $-22^{\circ}\text{F}/-30^{\circ}\text{C}$, above $140^{\circ}\text{F}/60^{\circ}\text{C}$. Do not use machine immediately after long–term extreme temperature storage. Before use, return battery module temperature range to $50^{\circ}\text{F}/10^{\circ}\text{C}$ – $95^{\circ}\text{F}/35^{\circ}\text{C}$

1. Completely drain the solution tank and recovery tank.

2. Pour 7.6 L (2 gal) of Propylene Glycol Based / Recreational Vehicle (RV) antifreeze into the solution tank.



3. Turn on the machine.

4. Press the 1–Step button.



T12

T12XP

5. Repeatedly press the *Solution increase button (+)* until the solution flow is at the highest setting.

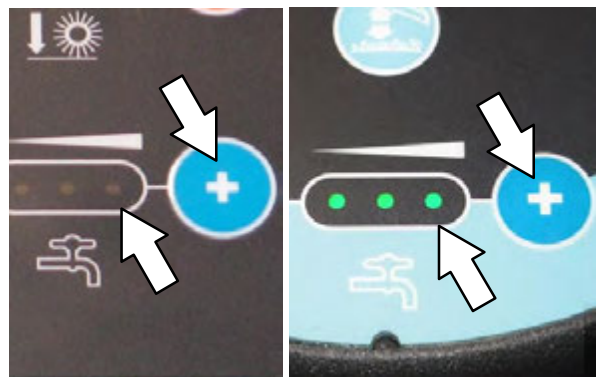

T12

T12XP

- Machines with ec-H2O option only:** Press the *scrub mode button* to place machine into the *ec-H2O* mode. The *ec-H2O* indicator light will illuminate.



T12

T12XP

- Machines with side brush option only:** Press the *side brush switch* to activate the side brush.

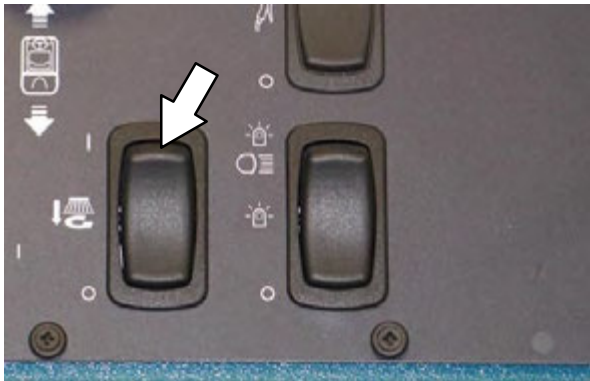

T12

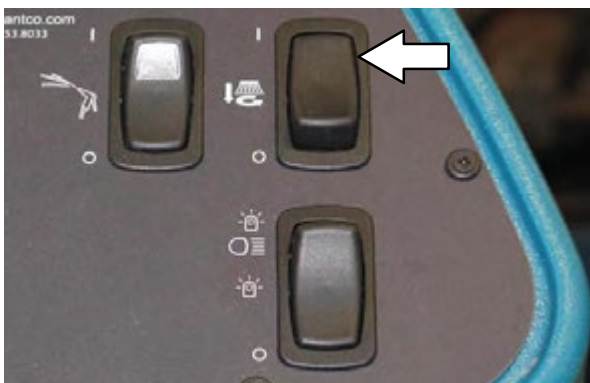

T12XP

- Drive the machine to circulate the RV antifreeze completely through all the systems and clear out any remaining water.
- Machines with side brush option only:** Press the *side brush switch* to turn off the side brush.
- Stop the machine.
- Machines with spray nozzle option only:** Operate the wand for a few seconds to protect the pump.
- Press the *1-STEP button* to turn off the system.
- Turn off the machine.
- The remaining RV antifreeze does not need to be drained from the solution or recovery tank.

MAINTENANCE

PREPARING THE MACHINE FOR OPERATION AFTER STORAGE

All Propylene Glycol Based / Recreational Vehicle (RV) Antifreeze must be completely cleaned from the scrubbing system before the machine can be used for scrubbing.

FOR SAFETY: Before leaving or servicing machine, stop on level surface and turn off machine.

1. Completely drain all Propylene Glycol Based / Recreational Vehicle (RV) antifreeze from the solution tank.
2. Rinse out the solution tank. Refer to *DRAINING AND CLEANING THE SOLUTION TANK* in the *OPERATION* section for instructions how to clean the solution tank.
3. Pour 11.4 L (3 gal) of cool clean water into the solution tank.



4. Start the machine
5. Press the 1-STEP button.



T12

T12XP

6. Repeatedly press the *Solution increase button (+)* until the solution flow is at the highest setting.

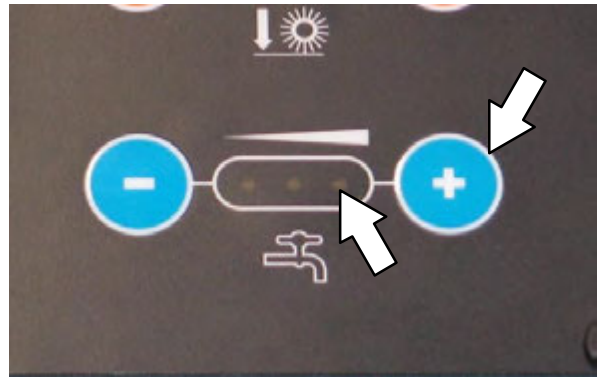

T12



T12XP

7. **Machines with ec-H₂O option only:** Press the *scrub mode button* to place machine into the ec-H₂O mode. The indicator light will illuminate.



T12

T12XP

NOTE: The ec-H₂O systems on machines equipped with ec-H₂O must be primed before the machine is ready for operation. See *PRIMING THE ec-H₂O SYSTEM* for additional instructions.

8. **Machines with side brush option only:**
Press the *side brush switch* to activate the side brush.

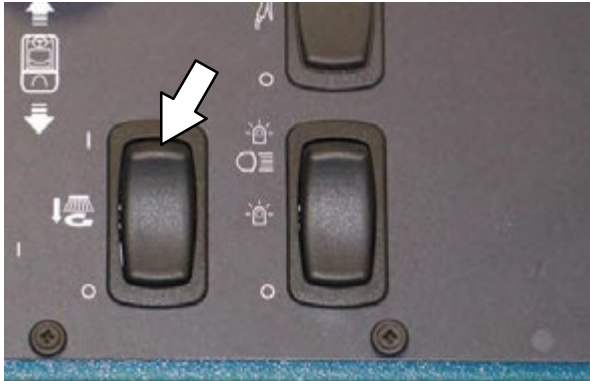

T12

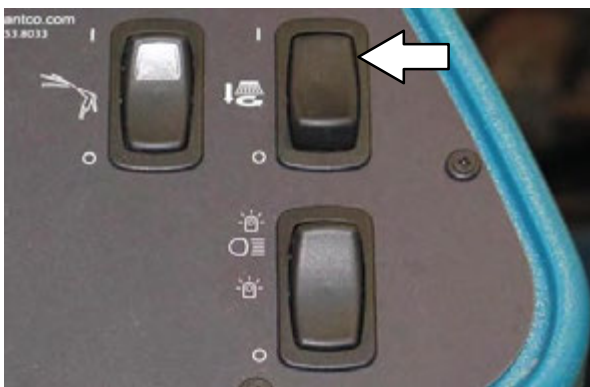

T12XP

9. Drive the machine to circulate the clean water completely through the system and clear out the RV antifreeze.
10. **Machines with side brush option only:**
Press the *side brush switch* to turn off the side brush.
11. Stop the machine.
12. **Machines with spray nozzle option only:**
Operate the wand for a few seconds to clean the RV antifreeze from the pump.
13. Press the *1-STEP button* to turn off the system.
14. Turn off the machine.
15. The remaining water does not need to be drained from the solution tank.

MAINTENANCE

PRIMING THE *ec-H2O* SYSTEM

Prime the *ec-H2O* system if the machine has been stored for a long period with no water in the solution tank / *ec-H2O* system.

FOR SAFETY: Before leaving or servicing machine, stop on level surface and turn off machine.

1. Fill the solution tank with clean cool water. See *FILLING THE SOLUTION TANK* section of this manual.



2. Lift the operator seat open and engage the seat support.
3. Remove the drain hose from the *ec-H2O* compartment.



4. Disconnect the outlet hose to the scrub head from the *ec-H2O* manifold.

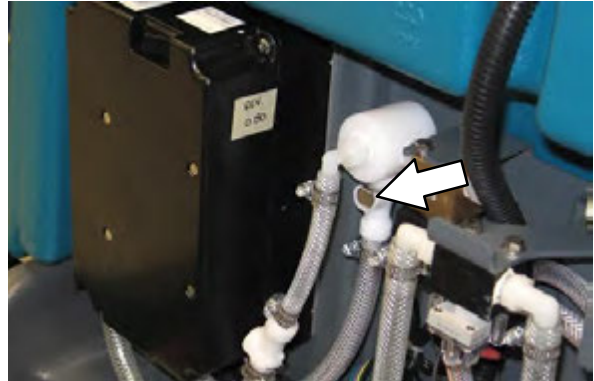

5. Place the drain hose into an empty container.
6. Connect the drain hose to the *ec-H2O* manifold hose disconnected from the outlet hose in the previous step.



7. Place the *ec-H2O* system outlet hose into an empty container.



8. Start the machine.

9. Press and release the *ec-H2O* module flush switch. Allow the system to drain water into the container for 2 minutes.

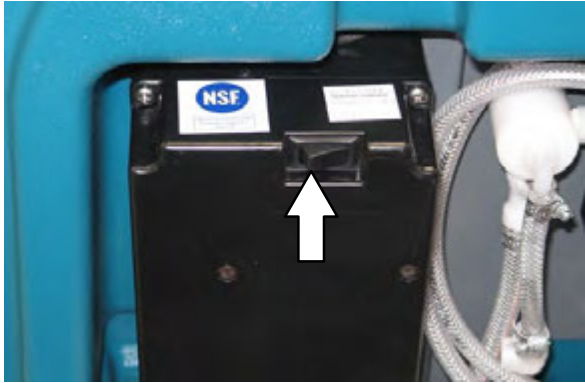

10. Press the *ec-H2O* module flush switch to shut off the system.
11. Disconnect the drain hose from the *ec-H2O* manifold hose.
12. Reconnect the outlet hose to the scrub head to *ec-H2O* manifold hose.
13. Place the drain hose back into the *ec-H2O* compartment.
14. Close the operator seat cover.

SPECIFICATIONS

SPECIFICATIONS

GENERAL MACHINE DIMENSIONS/CAPACITIES

Item	Dimension/capacity
Length	1710 mm (67.25 in)
Width (less squeegee)	945 mm (37.25 in)
Width (with squeegee)	990 mm (39 in)
Width (with side brush)	1065 mm (42 in)
Height	1420 mm (56 in)
Height with overhead guard	2095 mm (82.5 in)
Disk brush diameter for side brush (option)	330 mm (13 in)
Disk brush diameter	405 mm (16 in)
Cylindrical brush diameter	180 mm (7 in)
Cylindrical brush length	780 mm (30.7 in)
Scrubbing path width	810 mm (32 in)
Scrubbing path width (with side brush)	1040 mm (41 in)
Solution tank capacity	132 L (35 gallons)
Recovery tank capacity	166 L (44 gallons)
Demisting chamber	34 L (9 gallons)
Weight (Empty)	468 Kg (1030 lbs)
Weight (with standard 240 AH lead-acid batteries)	664 Kg (1460 lbs)
GVWR	1000 Kg (2200 lbs)
Protection Grade	IPX3

Values determined as per IEC 60335-2-72	Measure – Cylindrical scrub head	Measure – Disk scrub head
Sound pressure level L_{pA}	63 dB(A)	62 dB(A)
Sound uncertainty K_{pA}	3.0 dB(A)	3.0 dB(A)
Sound power level L_{WA} + Uncertainty K_{WA}	86.5 dB(A)	87.5 dB(A)
Vibration – Hand-arm	1.65 m/s ²	1.65 m/s ²
Vibration – Whole body	0.32 m/s ²	0.32 m/s ²
Vibration uncertainty K	0.20 m/s ²	0.20 m/s ²

GENERAL MACHINE PERFORMANCE

Item	Measure
Aisle turnaround width	1854 mm (73 in)
Travel Speed (Forward)	8 Km (5 mph)
Travel Speed while scrubbing (Forward)	6.1 Km (3.8 mph)
Travel Speed (Reverse)	4 Km (2.5 mph)
Maximum ramp incline for loading – Empty tanks	20% / 11°
Maximum ramp incline for scrubbing	7% / 4°
Maximum ramp incline for transporting (GVWR)	14% / 8°
Maximum ambient temperature for machine operation	43° C (110° F)
Minimum temperature for operating machine scrubbing functions	0° C (32° F)

POWER TYPE

Type	Quantity	Volts	Ah Rating	Weight
Lead-acid Batteries (Max. battery dimensions: 177.8 mm (7 in) W x 299.7 mm (11.8 in) L x 380 mm (15 in) H)	6	36	240 @ 20 hr rate	30 kg (67 lb)
	6	36	360 @ 20 hr rate	44 kg (97 lb)
Lithium-ion Battery	2 pack	36	110 / 4.1 kWh	51 Kg (112 lb)
	4 pack	36	221 / 8.2 kWh	83 Kg (183 lb)
	5 pack	36	276 / 10.2 kWh	98 Kg (217 lb)

Type	Use	VDC	kW (hp)
Electric Motors	Scrub brush (disk)	36	0.75 (1.00)
	Scrub brush (cylindrical)	36	0.75 (1.00)
	Vacuum fan	36	0.6 (0.8)
	Propelling	36	0.9 (1.2)

Type	VDC	amp	Hz	Phase	W	VAC
Charger (On-board)	36	20	50–60	1	720	115–240
Charger (Off-board)	36	21	45–65	1	756	85–265
Charger, Lithium-ion Battery (Standard, Off-board)	36	25	50–60	1	900	100–240
Charger, Lithium-ion Battery (Fast, Off-board)	36	33	50–60	1	1200	100–240

TIRES

Location	Type	Size
Front (1)	Solid	90 mm wide x 250 mm OD (3.5 in wide x 10 in OD)
Rear (2)	Solid	102 mm wide x 300 mm OD (4 in wide x 12 in OD)

STANDARD SOLUTION FLOW RATE

Item	Measure
Solution pump	36 Volt DC, 4.01 LPH (1.06 GPM) maximum

SPECIFICATIONS

SIDE BRUSH SOLUTION FLOW RATE (OPTION)

Item	Measure
Solution pump	36 Volt DC 0.95 LPM (0.25 GPM) maximum

ec-H₂O SYSTEM (OPTION)

Item	Measure
Solution pump	36 Volt DC, 5.13 LPM (1.36 GPM) min open flow
Solution flow rate (machines without optional side brush)	1.9 LPM (0.5 GPM) maximum
Solution flow rate (machines with optional side brush)	1.9 LPM (0.5 GPM) – (To main scrub head)
	0.95 LPM (0.25 GPM) – (To side brush)

MACHINE DIMENSIONS

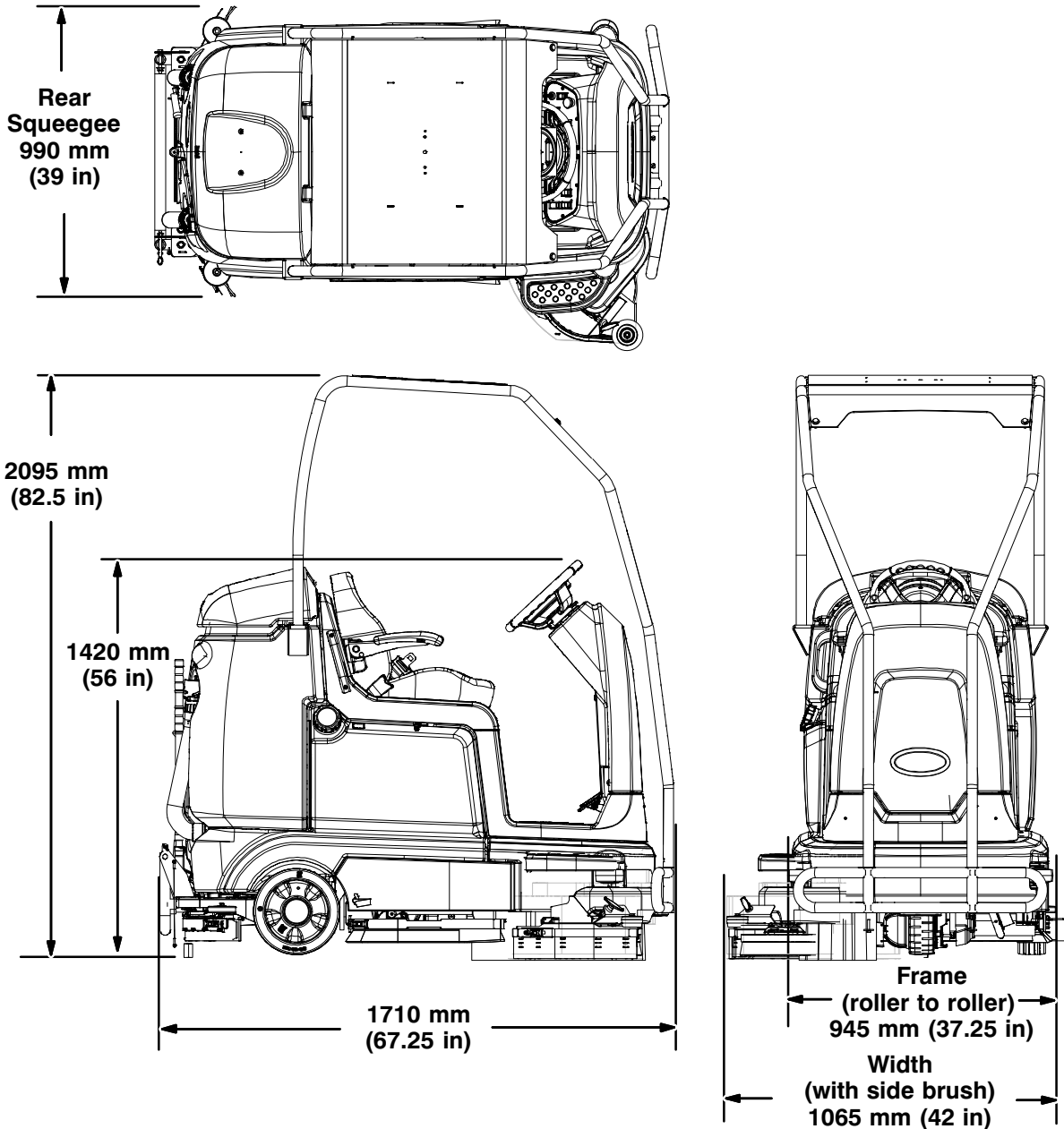

356389

1

1–STEP button, 19, 23, 24, 25, 26, 27

A

Adjust operator seat, 17
 Adjusting the Rear Squeegee Blade Deflection, 66
 Alarms, 32
 Fault Indicators, 32

B

Batteries, 43
 Changing on–board battery charger fuse, 49
 Charging batteries (off–board charger), 44
 Charging batteries (on–board charger), 45
 Checking connections / cleaning, 43
 Checking the electrolyte level, 43
 Flooded (wet) and Maintenance–Free Sealed lead–acid Batteries, 43
 Flow–Rite battery watering system (option), 50
 Hydrolink Battery Watering System (option), 52
 Installing Batteries, 14
 Flooded/Sealed Lead–acid Batteries, 14
 Lithium–ion Battery, 15
 Lithium–ion Battery Pack, 44
 Maintenance, 43
 Manual Battery Watering System (option), 54
 On–board battery charger error codes, 46
 On–board battery charger settings, 47
 Battery discharge indicator, 15
 Battery Specifications, 14
 Battery Watering System (option), 54
 Belts, 70
 Cylindrical brush drive belt, 70
 Belts and Chains, Cylindrical brush drive belt, 70
 Brake pedal, 18
 Brush and Pad Information, 20
 Brush Information, 20
 Brush pressure decrease button, 24
 Brush pressure increase button, 24
 Buttons
 1–STEP button, 25
 Brush pressure decrease button, 24
 Brush pressure increase button, 24
 Configuration mode button, 18
 Contrast control button, 18
 ec–H2O button, 23
 Solution decrease button, 24
 Solution increase button, 24
 Solution on / off buttons, 19

Vacuum fan / squeegee, 19
 Vacuum fan/squeegee button, 26, 27

C

Capacities, 82
 Changing on–board battery charger fuse, 49
 Circuit breakers, 56
 Configuration mode button, 18
 Contents, 1
 Contrast control button, 18
 Controls
 1–STEP button, 25
 Brush pressure decrease button, 24
 Brush pressure increase button, 24
 Circuit breakers, 56
 Directional switch, 18
 ec–H2O button, 23
 Emergency shut–off button, 16
 Key switch, 22
 Operating / hazard light switch (Option), 16
 Scrub mode button, 19
 Side brush switch (option), 37
 Solution decrease button, 24
 Solution increase button, 24
 Solution on / off buttons, 19
 Spray nozzle switch (option), 34
 Controls and Instruments, 12
 Touch Panel (Standard), 10
 Touch Panel (XP), 12
 Controls and Instruments (Standard), 9
 Controls and Instruments (XP), 11
 Cylindrical brushes, Replacing brushes, 60

D

Debris trough, 29
 Dimensions, 82
 Directional switch, 18
 Disable the parking brake, 71
 Disk Brush, Replacing, 58
 Disk brushes, 58 – 63
 Disk Pads, Replace, 59
 Disk Scrub Brushes, Replacing, 58
 Disk Scrub Pads, Replace, 59
 Double Scrubbing, 26
 Draining and Cleaning the Recovery Tank, 28
 Draining and Cleaning the Solution Tank, 30

E

ec–H2O Scrubbing System, Indicator Light Codes, 25

ec–H2O Scrubbing System Indicator Light Codes , 25

ec–H2O System, Specifications, 84

ec–H2O button, 23

ec–H2O Module Flush Procedure, 74

Electric motors, 57

Electrical system

- Batteries, 43
 - Checking connections / cleaning, 43
 - Checking the electrolyte level, 43
 - Flooded (wet) and Maintenance–Free Sealed lead–acid Batteries, 43
 - Lithium–ion Battery Pack, 44
- Changing on–board battery charger fuse, 49
- Charging batteries (off–board charger), 44
- Charging batteries (on–board charger), 45
- Circuit breakers, 56
- Electric motors, 57
- On–board battery charger settings, 47

Emergency shut–off button, 16

Error codes, On–board battery charger, 46

F

Fault Indicators, 32

Filling the Solution Tank, 22

- Conventional Scrubbing Mode, 23
- ec–H2O scrubbing (ec–H2O Mode), 22

Flow–Rite battery watering system (option), 50

Flush Procedure, ec–H2O Module, 74

Freeze Protection, 76

H

Hour Meter, 15

How the Machine Works, 19

Hydrolink Battery Watering System (option), 52

I

Indicator Light Codes, ec–H2O Scrubbing System, 25

Indicators

- Battery discharge, 15
- Fault Indicators, 32
- Hour Meter, 15
- Recovery tank full, 15
- Warning codes, 33

K

Key switch, 22

L

Leveling the Rear Squeegee, 65

Lights, Operating / hazard light switch (Option), 16

Lithium–ion Battery Pack, 44

Lubrication, 42

- Rear squeegee caster pivot points, 42
- Steering chain, 42
- Steering gear chain, 42

M

Machine components, 8

Machine Dimensions, 84

Machine Jacking, 73

Machine operation

- Double scrubbing, 26
- Pre–Operation Checklist, 21
- Scrubbing, 25
- Start the machine, 22
- Stop scrubbing, 27
- Turning off the machine, 31

Machine Performance

- Aisle Turnaround Width, 83
- Climb and Descent Angles, 83
- Travel Speed (Maximum), 83

Machine Specifications, 82 – 85

Machine tie down location, 72

Machine Troubleshooting, 38

Maintenance, 40 – 64

- Batteries, 43
 - Checking connections / cleaning, 43
 - Checking the electrolyte level, 43
 - Flooded (wet) and Maintenance–Free Sealed lead–acid Batteries, 43
 - Lithium–ion Battery Pack, 44
- Belts, 70
- Charging batteries (off–board charger), 44
- Charging batteries (on–board charger), 45
- Changing on–board battery charger fuse, 49
- Circuit Breakers, 56
- Cylindrical brushes, 60 – 65
- Disk brushes, 58 – 63
- ec–H2O Module, 74
- Lubrication, 42
- Machine Jacking, 73
- On–board battery charger settings, 47
- Pushing, Towing, and Transporting the Machine, 71

Replacing cylindrical brushes, 60
 Side Brush (Option), 61
 Skirts and Seals, 70
 Squeegee Blades, 62
 Storage Information, 76
 Tires, 70
 Yellow touch points, 42
 Maintenance Chart, 40

O

On-board battery charger error codes, 46 – 51
 Operating / hazard light switch (Option), 16
 Operating temperature, 21
 Operation, 8 – 32
 Operation of controls, 15
 Operator seat, 17
 Operator seat release handle (deluxe seat only),
 17
 Options, 34 – 36
 Rear Squeegee Guard, 36
 Side brush, 37
 Spray Nozzle, 34
 Vacuum wand, 35

P

Pad Driver, Replacing, 58
 Pad Information, 20
 Parking brake, Disable the parking brake, 71
 Pedals
 Brake pedal, 18
 Propel pedal, 18
 Pre-Operation Checklist, 21
 Preparing the machine for operation after
 storage, 78
 Priming the ec-H₂O system, 80
 Propel pedal, 18
 Pushing or Towing the Machine, 71
 Pushing, Towing, and Transporting the Machine,
 71
 Pushing or Towing the Machine, 71
 Transporting the Machine, 71

R

Rear Squeegee
 Adjusting the Rear Squeegee Blade Deflection,
 66
 Leveling the Rear Squeegee, 65

Rear Squeegee Blade, Replacing (or Rotating)
 the Rear Squeegee Blade, 62
 Rear Squeegee Guard (option), 36
 Rear Squeegee, Replacing (or Rotating), 62
 Recovery tank full indicator, 15
 Recovery Tank Seal, 70
 Replacing (or Rotating) the Rear Squeegee
 Blades, 62
 Replacing or Rotating the Side Brush Squeegee
 Blade (Option), 68
 Replacing or Rotating the Side Squeegee
 Blades, 67
 Replacing the Side Brush (Option), 61

S

Safety
 Labels, 6
 Lithium-ion Battery Label, 7
 Precautions, 3 – 5
 Scrub brushes
 Cylindrical brushes, 60
 Replacing cylindrical brushes, 60
 Scrub Brushes and Pads, 58
 Disk brushes, 58
 Replacing Disk Brushes or Pad Driver, 58
 Replacing Disk Scrub Pads, 59
 Scrub head skirt (Disk scrub heads only), 70
 Scrubbing, 25
 Double scrubbing, 26
 Stop scrubbing, 27 – 29
 Seals, 70
 Recovery Tank Seal, 70
 Seat belts, 17
 Seat support, 17
 Seat, Operator, 17
 Setting Brush Pressure, 24
 Setting Scrub Modes
 Setting Brush Pressure, 24
 Setting Solution Flow, 24
 Side Brush (Option), 37, 61
 Replacing or Rotating the Side Brush
 Squeegee, 68
 Replacing the Side Brush, 61
 Side Brush Squeegee (Option), Replacing or
 Rotating, 68
 Side Brush System, Specifications, 84
 Side Brush, Replacing, 61

Side Squeegee Blades, 67
 Replacing or Rotating the Side Squeegee
 Blades, 67

Side Squeegee Blades, Replacing or Rotating,
67

Skirts, Scrub head skirt (Disk scrub heads only),
70

Skirts and Seals, 70
 Recovery Tank Seal, 70
 Scrub head skirt (Disk scrub heads only), 70

Solution decrease button, 24

Solution increase button, 24

Solution on / off buttons, 19

Specifications, 82 – 85
 ec-H2O System, 84
 Machine Capacities, 82
 Machine Dimensions, 82
 Machine Performance, 83
 Power Type, 83
 Side Brush System, 84
 Standard solution flow rate, 83
 Tires, 83

Spray Nozzle (Option), 34

Squeegee Blades, 62
 Adjusting the Rear Squeegee Blade Deflection,
 66
 Leveling the Rear Squeegee, 65
 Replacing (or Rotating) the Rear Squeegee
 Blades, 62
 Replacing or Rotating the Side Brush Squeegee
 Blade (Option), 68
 Replacing or Rotating the Side Squeegee
 Blades, 67

Standard solution flow rate, Specifications, 83

Start the machine, 22

Storage Information, 76
 Freeze Protection, 76
 Preparing the machine for operation after
 storage, 78
 Priming the ec-H2O system, 80

Switches
 Directional switch, 18
 Emergency shut-off button, 16
 Key switch, 22
 Operating / hazard light switch (Option), 16
 Side brush switch (option), 37
 Spray nozzle switch (option), 34

Symbol definitions, 13 – 15

T

Temperature, Operating, 21

Tie down location, 72

Tires, 70
 Specifications, 83

Touch Panel (Standard), 10

Touch Panel (XP), 12

Touch points, yellow, 42

Towing the Machine, 71

Transporting the Machine, 71

Troubleshooting Table, 38

Turning off the machine, 31

V

Vacuum fan / squeegee button, 19

Vacuum wand (option), 35

W

Warning codes, 33

Warning Indicators, 15

Water Pickup Mode (No Scrubbing), 27

Wheels, 70

While Operating the Machine, 21